

IP Power 9823GP-RL

Ethernet-based Data Acquisition and Power Control Module

User Manual

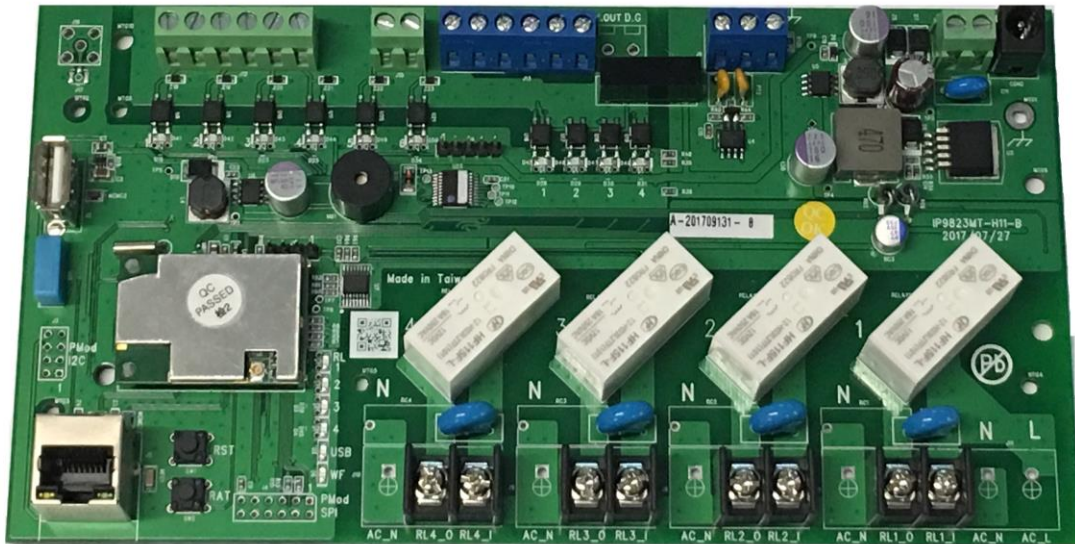

Version : V1.01
Firmware Version: V1.04
Date Released: MAY . 2018

COPY RIGHT

Copyright © 2018 All rights reserved. No part of this publication may be reproduced, stored in a retrieval system, or transmitted in any form or by any means, electronic, mechanical, photocopying, recording or otherwise, without the prior written consent of us. All trademarks and products mentioned in this document are the properties of us.

The documentation and the software included with this product are copyrighted 2018 by Aviosys International Inc. All rights are reserved.

Aviosys International Inc reserves the right to make improvements in the products described in this manual at any time without notice. No part of this manual may be reproduced, copied, translated or transmitted in any form or by any means without the prior written permission of Aviosys International Inc. Information provided in this manual is intended to be accurate and reliable. However, Advantech Co., Ltd. assumes no responsibility for its use, nor for any infringements of the rights of third parties, which may result from its use.

IMPORTANT NOTICE

- * The product was designed for indoor use, we carry no responsibility for possible damages caused by outdoor use, especially in the rain
- * Please use the power adapter provided by the dealer, we carry no responsibility for the possible damage from using power adapters not provided by us .
- * Please contact the dealer If IP Power 9823 is not working properly.

- * **Warning:** Any changes made to this equipment without permission may cause damages to the device! .

Contents

1. INTRODUCTION.....	5
1.1 Overview	5
1.2 Main Features	7
1.2.1 Hardware Features	7
1.2.2 Firmware feature	8
1.2.3 Ethernet I/O control board , Modbus TCP/IP & BacNet TCP/IP.....	8
1.3 Product Specification	9
1.3.1 Basic	9
1.3.2 Latching Relay Output.....	9
1.3.3 Digital Input (DI).....	10
1.3.4 Digital Output	10
1.3.5 RS-485	10
1.3.6 Humidity Temperature Sensor	10
1.3.7 Protection:	10
1.3.8 Environment:	11
1.3.9Dimensions:	11
1.4 IO Interface	11
2. HARDWARE INSTALLATION	13
2.1 Before Starting	13
2.1.1 Package :	13
2.1.2 Minimum system Requirements :	13
2.2 Hardware Connection.....	13
2.2.1 Power supply connection	14
2.2.2 IO connection.....	14
3. SYSTEM CONFIGURATION	21
3.1 Hardware configuration	21
3.2 Network Connection :.....	21
3.2 Software configuration	22
3.2.1 Software installation	22
3.2.2 Software overview	23
3.2.3 Using IP Service (& CNT).....	26
3.3 Internet Setup.....	27
4 WEBPAGE INTERFACE OVERVIEW.....	28

4.1 Information	29
4.1.1 Device Name :	29
4.1.2 Display.....	29
4.1.3 Time	30
4.1.4 Humidity & Temperature status	30
4.2.1 DI-DO	31
4.2.2 Schedule.....	46
4.2.3 Ping	51
4.3 Network :	56
4.4 Application Settings	57
4.4.1 Email	57
4.4.2 DDNS.....	61
4.4.3 Communication	62
4.4.4 IP Service.....	64
4.5 System Setting	65
4.5.1 Management	66
4.5.2 System Information	69
4.5.3 System Log	70
4.5.4 Firmware.....	70
5.CONTROLLING THE DEVICE	72
CGI HTTP Commands	72
Telnet Control	74
6.FAQ :.....	74

1. Introduction

1.1 Overview

Ethernet-based Data Acquisition and Power Control Module / Ethernet Peripheral Digit IO controller

The IP9823GP-RL is a cost effective solution for data acquisition, monitoring and control through network. The module provide IO for data acquisition, Relay for power control module and embedded webserver for a wide application. IP9823 Series also provides an excellent web server and complete network and industry standard protocols. It is easily integrated with existing system and play a high performance network control.

With **latching type relay**, with RS485 interface to be MODBUS Gateway – 9823 is a stable and powerful bridge of Modbus /TCP Server on network and the Modbus devices

Please refer the following picture for the overview of IP9823GP-RL

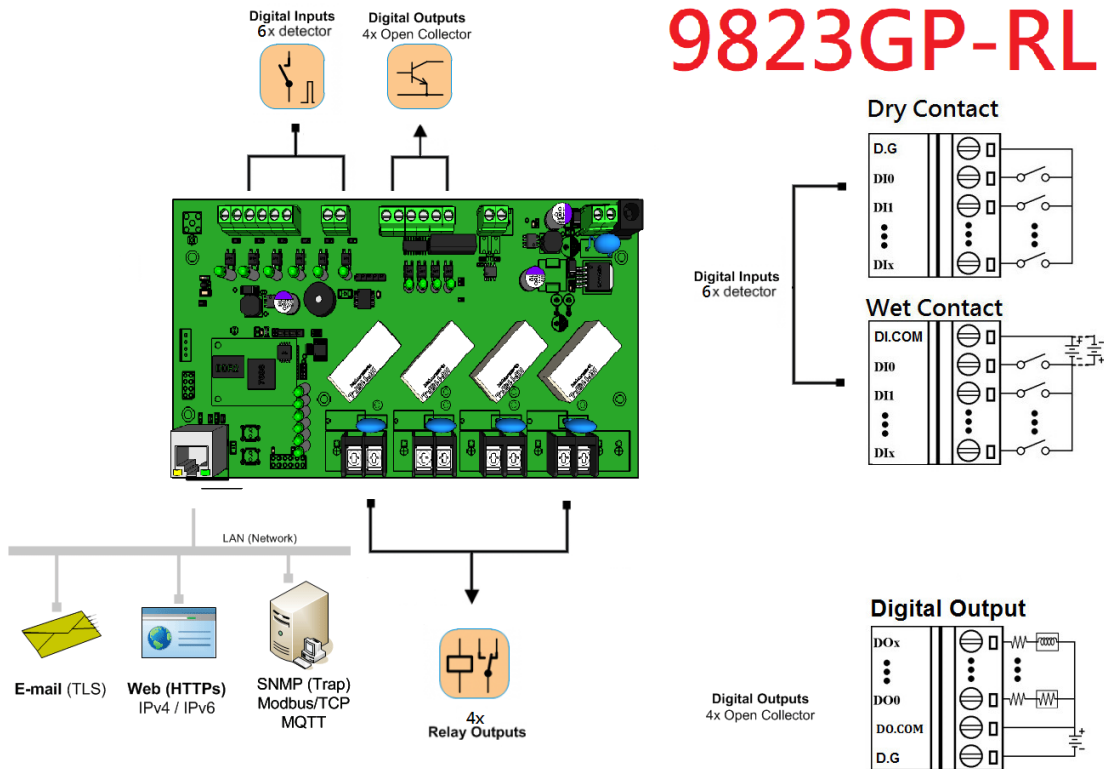

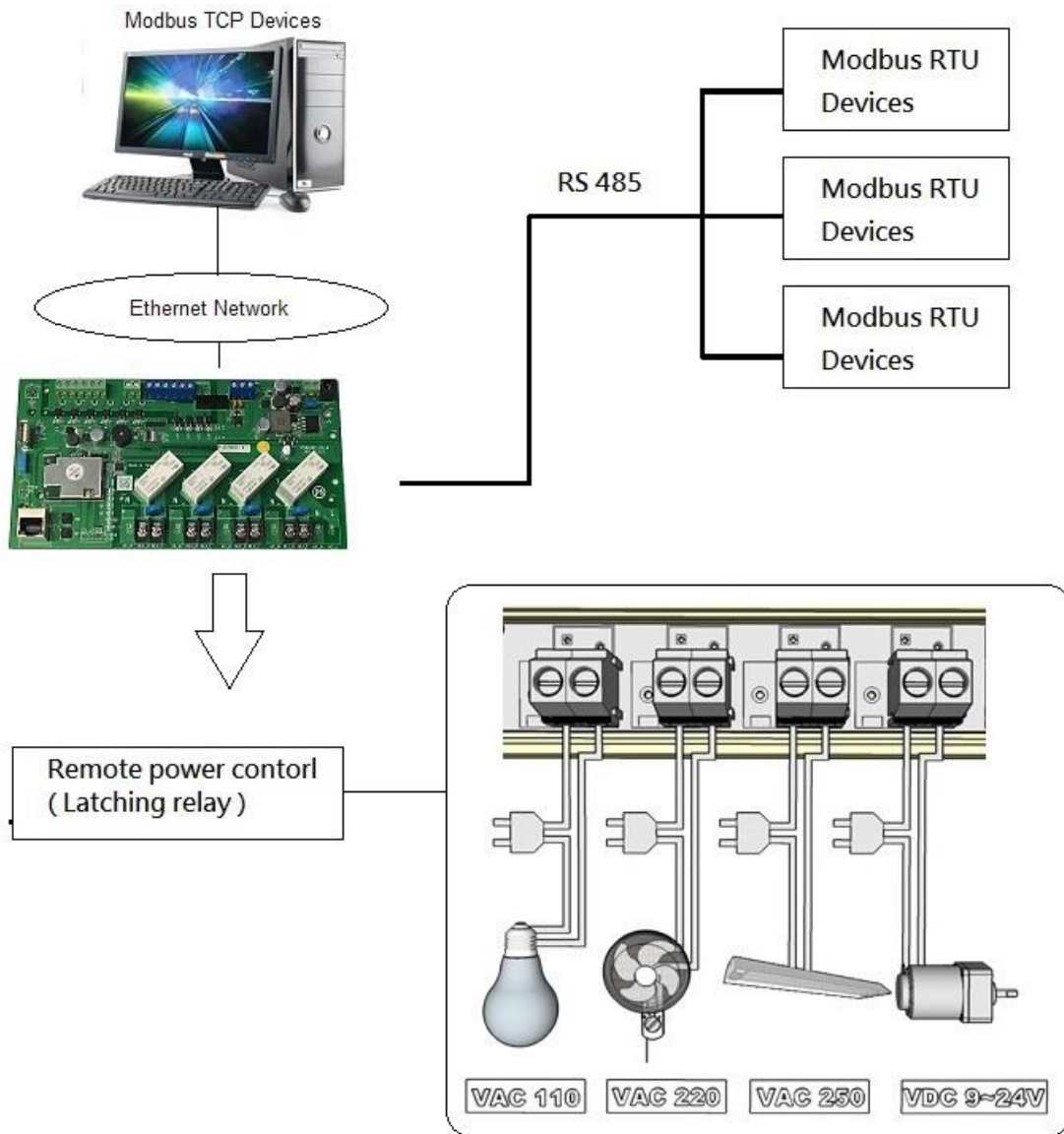



1.2 Main Features

1.2.1 Hardware Features

	Item	Description
1	4 Latch Type Relay 16A/250V (memory relay)	Low power dissipation, lower spike, NO heat & More durable!
2	4 DO Programable output	COM power voltage is up to 50V, open drain design. Provide 4 type 400ma pull down output. * DC(Pull Down / Off) * Pulse(power cycle) output with 16bit Down counter * 2K~ 50Hz Frequency output * Only DO# 1 support pulse width modulate) output
3	4 DI 4 General purpose digital input	Provide both type input 1. 500ohm Resistance dry contact input 2. detect (50V~4.5V)/(0~ 3V) logic High/Low bi-direction wet contact input
4	2 special DI *For IP9823GP models only	Provide 3 type input 1. DC logic High/Low detect (Dry/Wet contact) 2. Tachometer (up to 2KHz /120K rpm) 3. 32bit Tally Counter
5	USB Port(option)	For extended HID/CDC and Camera/Storage device/3G dongle
6	Thermal /Humidity sensor	Temperature: -20 ~ +60 °C / - 4 ~ +136 °F Humidity: 20-95% RH
7	RS485 bus	receive/send RS485 message to internet
8	PMOD connect (option)	option to I2C/SPI gas, temp/current ADC sensor
9	Antenna (option)	option to wireless LAN (FCC certificated only)
10	Notification	1. On board Beeper sound notification. 2. LED I/O indication 3. Network notification for Mail / SNMP / Syslog
11	Protection	Isolation Voltage 3,000 VDC . Power Reversal Protection detect self watch dog timeout reboot. ping network failure action

1.2.2 Firmware feature

	Item	Description
1	Network	Web server, UPNP , DDNS & Telnet Modbus to Modbus/TCP gateway NTP server & SMTP server Support most Ethernet protocol: DHCP, UDP/TCP/IP, HTTP
2	Security	SSL3.0 , HTTPS, SNMP V2. SMTP (Gmail , hotmail) Web server provide 3 levels authentication: Administrator, Operator, Guest Base64 password encrypt
3	Event, Alarm Notification	1. SMTP mail notification. 2. Syslog server notify 2. Ping failure event action. 4. Scheduler event action 5. I/O level change & Temperature, Frequency Change
4	SDK and Industrious Protocol	Provide HTTP CGI command , SNMP V2 & POP3 Mail control . Modbus/TCP & Bacnet/TCP.
5	IOT/ Device-to-Cloud Architecture	CNT (Aviosys server) Standard MQTT (Message Queue Telemetry Transport) protocol - Apply on Amazon, Baidu, Alibaba available
6	Windows AP	IP Power center (manager and control all Aviosys product), IPEdit (local/internet search) & Online webpage search www.myipedit.com (internet search)
7	Mobile APP	* All support APP for Android or iOS system : - Android APP -- name "IP Power free download in Google Play . - iOS APP -- name "IPPOWER+ " free download in Apple AppStore IPPower+ (iOS) & IPPower (Android)  
8	Wireless LAN(Optional)	(FCC certificated only, default disable) AP client mode support (extend wireless LAN range) & WPS

1.2.3 Ethernet I/O control board , Modbus TCP/IP & BacNet TCP/IP

IP9823GP-RL is a module with embedded webserver and based on standard ethernet networking 10/100 Mbps Ethernet and support popular Modbus /TCP or and BacNet /TCP protocols over TCP/IP for data connection .

1.3 Product Specification

1.3.1 Basic

- Network LAN 10/100Base-T(X)
- Power Input 12 ~ 30 VDC (Reversal Protection)
- Power Consumption : 2W @ 12 VDC (IP9823LT)
 - 2.16W @ 12 VDC (IP9823GP)
- Connectors 1 x RJ-45 (LAN), Plug-in screw terminal block (I/O and power)
- Watchdog Timer System (1.6 second) and Communication (programmable)
- Support Peer-to-Peer
- Support protocol: - Network : HTTP, UDP/TCP, DHCP, SMTP,
 - iot/cloud : MQTT, UPNP
 - industry : HTTP CGI, SNMP, Modbus/TCP, Bacnet/TCP,
Modbus RTU
- USB 2.0 for extended future HID, CDC, Camera, Storage requirement.
- PING Call Timer System
- Build in RTC timer for schedule
- Option: Wireless LAN extendable

1.3.2 Latching Relay Output

4 pcs Latching type relay and each relay can switch power .

- max. 260 VAC @ 16 A . max. 30 VDC @ 5A
- Relay On Time 15 ms . Relay Off Time 8 ms
- Max. Switching 20 operations/minutes

1.3.3 Digital Input (DI)

Provide 6 DI with both dry contact and wet contact. **IN ch5 and ch6. of DI can be assigned to a tally counter or Tachometer.**

DI	Logic Level 0	Logic Level 1	Notice
Dry	Below 500 Ohm resistance close to GND signal.	3 VDC	
Wet	Open	5-50 VDC	Connector +/- protection

1.3.4 Digital Output

- 4 Channels Digital Output
- Provide 4 of open collector type to pull down output. Sink voltage max. 5~40 VDC source to GND. (max. current 400mA). Power Dissipation
 - Each Channel: 400mA max.
 - Total current: 1.5A max.(4 Channels)
- each channel can be assigned a 16bits pulse count
- each channel can be assigned a frequency output (2K ~ 50Hz)
- one channel can be assigned a programmable PWM output

1.3.5 RS-485

1-ch RS-485 ASCII command and Modbus RTU to Ethernet-based(Modbus TCP)

Baud-rate and address is configured from web page

1.3.6 Humidity Temperature Sensor

The Humidity Temperature Sensor on the board. Sensing range

- Temperature: -20 ~ +60 °C / - 4 ~ +136 °F
- Humidity: 20-95 % RH

1.3.7 Protection:

Isolation Voltage 3K VDC . & Power Reversal Protection

1.3.8 Environment:

- Operation: Temperature -10 ~ 70°C (14 ~ 158°F) .
Humidity 20 ~ 95% RH (non-condensing).
- Storage: Temperature -20 ~ 80°C (-4 ~ 176°F) .
Humidity 0 ~ 95% RH (non-condensing)

1.3.9 Dimensions:

- 200 x 107x 20 mm (L/W/ H)
- 203x 122x 50 mm (L/W/ H) (w/ Din Rail Stand)

1.4 IO Interface

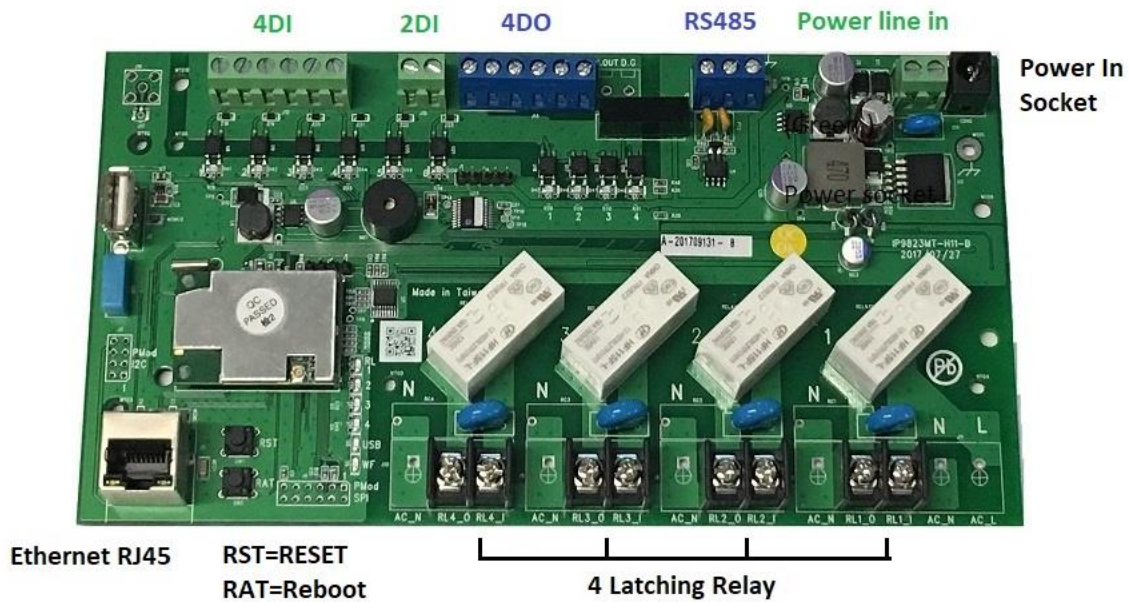

Upper : 4DI , 2DI , 4DO , RS485 ,
Power line in and power in socket . (Only select one power input)

Down : Ethernet (RJ 45) , Reset , Reboot and 4 Latching Relays

Description	Function
4DI General purpose digital input	Provide both type input 1. 500ohm Resistance dry contact input 2. detect (50V~4.5V)/(0~3V) logic High/Low bi-direction wet contact input
2 DI special	Provide 3 type input 1. DC logic High/Low detect (Dry/Wet contact) 2. Tachometer (up to 2KHz /120K rpm) 3. 32bit Tally Counter
4DO Programable output	COM power voltage is up to 50V, open drain design. Provide 4 type 400ma pull down output. * DC(Pull Down / Off) * Pulse(power cycle) output with 16bit Down counter * 2K~ 50Hz Frequency output * Only DO# 1 support PWM (pule width modulate) output
RS485	Receive/send RS485 message to internet
Power line in	Power input : for line input 12 ~ 30 VDC
Power in socket	Power input : for power adaptor 12V 1A VAC
Network	10/100 Mbps , Ethernet RJ 45connector
RST = Reset	Set back to manufactory default
RAT = Reboot	Reboot the device power
4 Latch Type Relay	16A/250V (memory relay) Low power dispassion, lower spike, no heat more durable!

2. Hardware installation

2.1 Before Starting

*Before setting up the device make sure of the following:

- 1.) All the package contents are all included if anything is missing please contact the dealer where the device was purchased from.
- 2.) Check the power input cable is working correctly.
- 3.) Check all cables to make sure there are no problems with it.

2.1.1 Package :

- Standard :
 - IP 9823GP-RL .
 - CD with manual and software
- Option :
 - Power adaptor (12V 1A) .
 - Network cable (RJ45 connector) .
 - Din Rail mount

2.1.2 Minimum system Requirements :

- Windows OS with network capacity & web browser .
Like Google Chrome , Safari , **IE 9.0 or above** .
- Ethernet Hub /Switch (at least 2 ports)
- Ethernet cable with RJ45 connector
- Power supply for IP9823GP-RL (12 ~ 30 VDC unregulated)

2.2 Hardware Connection

This section provides basic information on wiring the power supply, I/O units, network connection and LED display .

2.2.1 Power supply connection

There are two power source for IP9823GP-RL .

1. Power line in : 12 to 30 VDC (in Green socket)
2. Power adaptor : 12V 1A VAC (in Black socket)

MUST only select one power input .

Either use
Power line in



Or use
Power socket .

2.2.2 IO connection

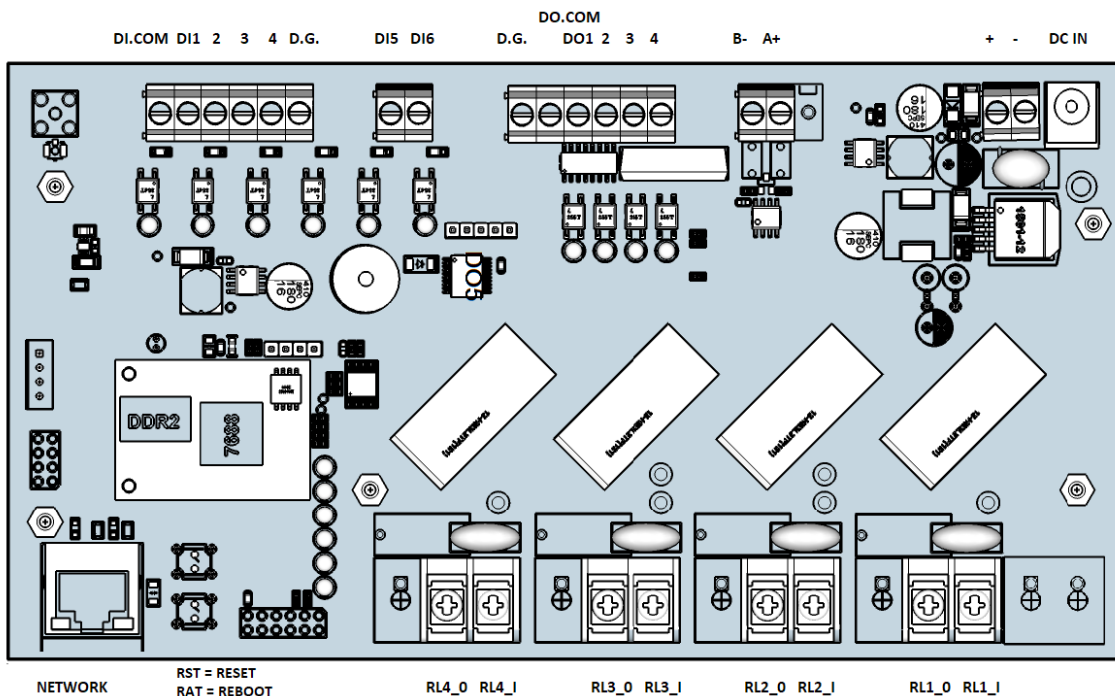

The system uses a plug-in screw terminal block for the interface between I/O modules and field devices. The following information must be considered when connecting electrical devices to I/O modules.

2.2.2.1 DI

1. Location :

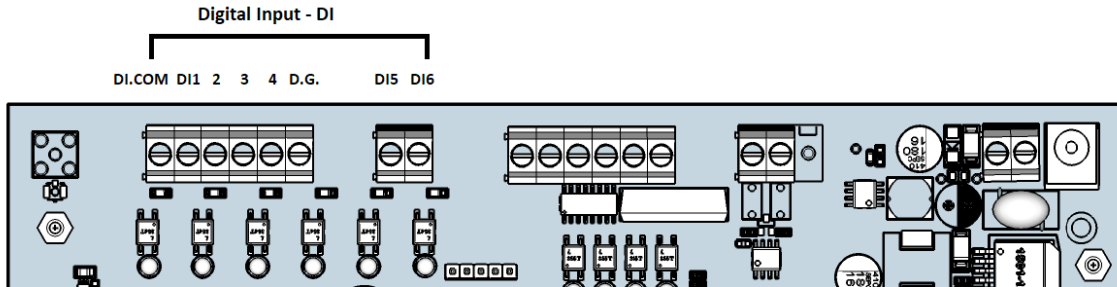

2. Connection :

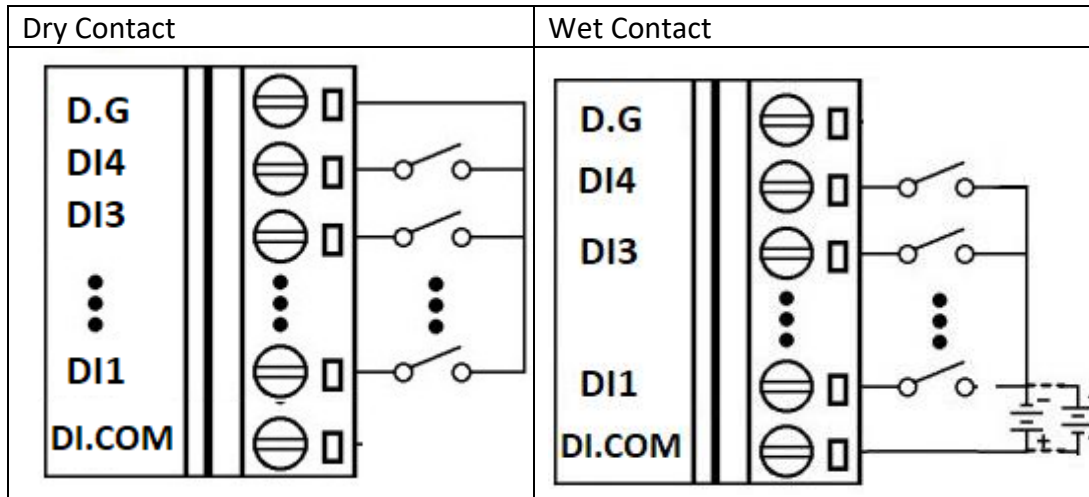

3. Specification :

Provide 6 DI with both dry contact and wet contact. There are two DI with different function which can be assigned to a tally counter or Tachometer. Those are **DI#5 and DI#6**

3-1 : DI#1 , 2 , 3 & 4 , General purpose digital input. Provide both type input

* 500ohm Resistance dry contact input

* Detect (50V~4.5V) /(0~ 3V) logic High/Low bi-direction wet contact input

3-2 : DI #5 & # 6 , special . Provide 3 type input

* DC logic High/Low detect (Dry/Wet contact)

* Tachometer (up to 2KHz /120K rpm)

* Tally Counter (32 bit)

2.2.2.2 DO

1. Location :

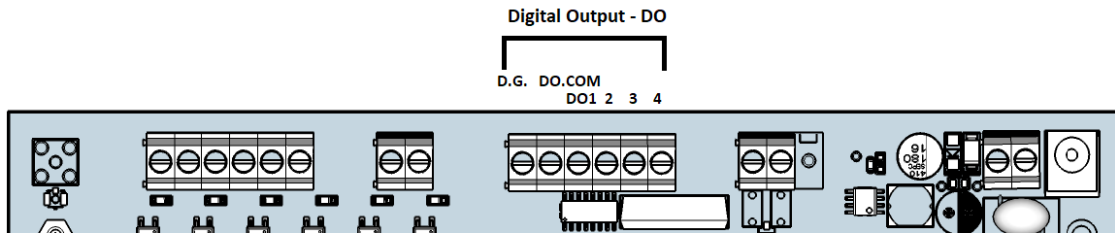

2. Connection :

Digital Output

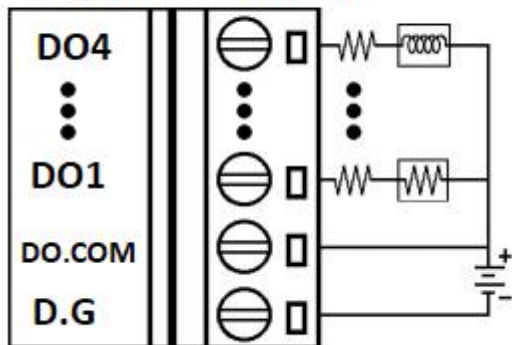

3. Specification :

The 4 DO are programmable outputs . COM power voltage is up to 50V, open drain design.

Provide 4 type 400ma (MAX.) pull down output.

* DC(Pull Down / Off)

* Pulse(power cycle) output with 16bit Down counter

* 2K~ 50Hz Frequency output

* Only DO# 1 support PWM (pule width modulate) output

2.2.2.3 Relay

1. Location :

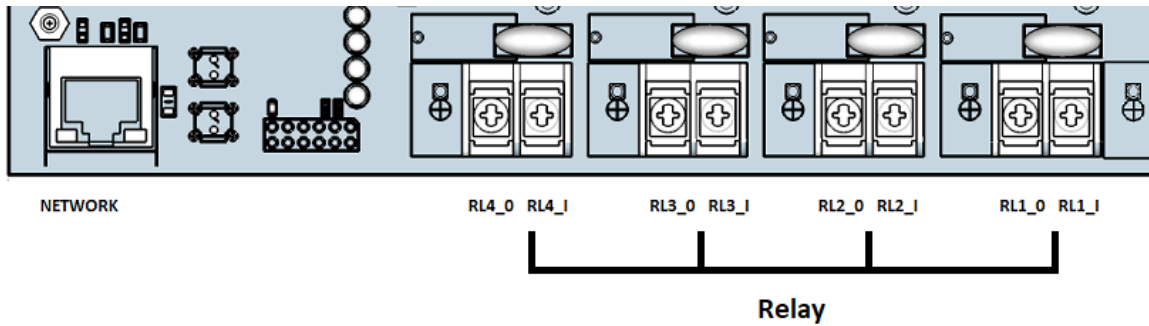

2. Connection :

Relay number from left to right : Relay # 4 , 3 , 2 & 1

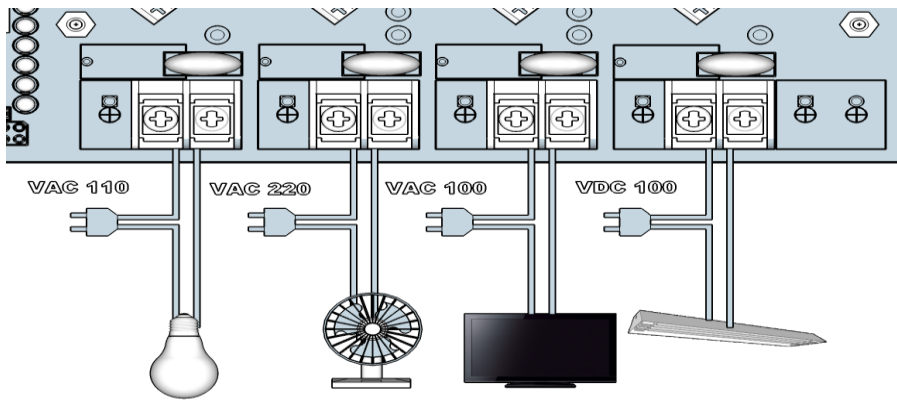

3 . Specification :

4 Latch Type Relay: 16A/250V (**memory relay**) Low power dissipation, lower spike, no heat more durable!

Latching type relay and each relay can switch power .

* max. 260 VAC @ 16 A . max. 30 VDC @ 5 A

* Relay On Time 15 ms . Relay Off Time 8 ms

*Max. Switching 20 operations/minutes

2.2.2.4 RS485

User can receive or send RS485 message to internet .

1. Location :

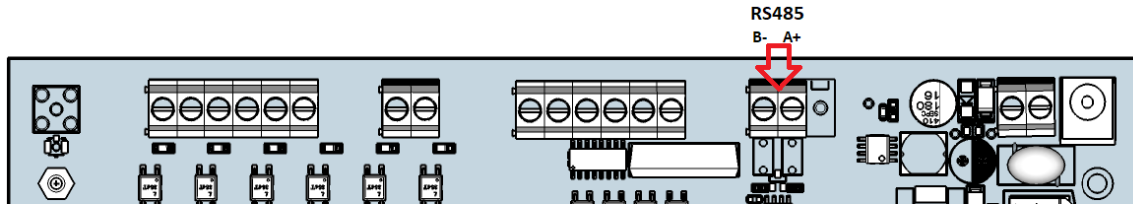

2. Connection :

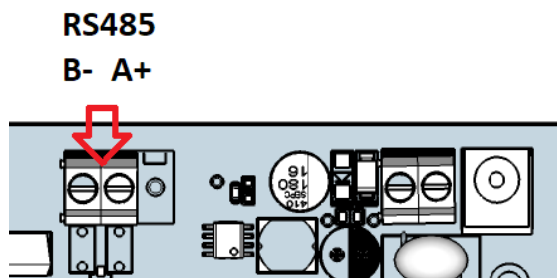

3. Specification : Standard RS485 interface .

2.2.2.5 USB

For 4G Dongle application.

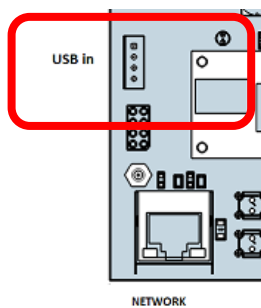

2.2.2.6 Thermal / Humidity sensor

1. Location :

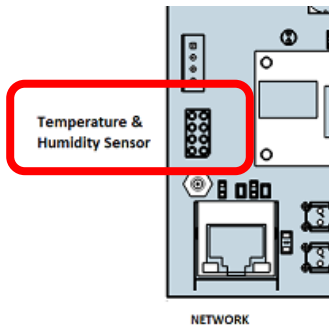

2. Specification :

The Humidity Temperature Sensor on the board. Sensing range

- Temperature: -20 ~ +60 C
- Humidity: 20 ~ 95 RH%

2.2.2.7 LED Indicators

There are LED lights near the IO to indicate the IO status

• Led lights for DI , DO , Relay , USB and Power

Location :

- 6 DI : in yellow
- 4 Relay : in blue
- 1 WF : power
- * 4 DO : in orange
- * USB : in purple

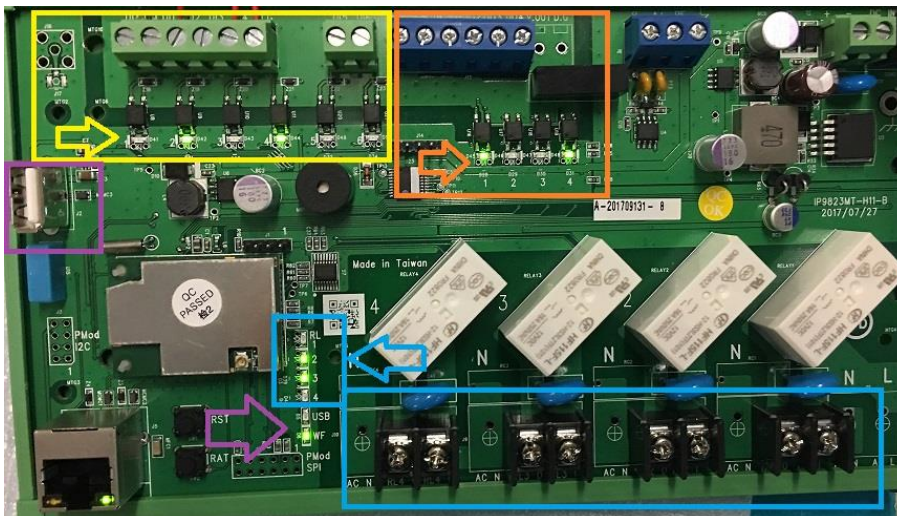

2.2.2.8 Network connection

Please refer following procedure :

- 1.) Connect the Ethernet cable (RJ45) to the 9823 to user HUB/Switch .
- 2.) Then connect the power cable into the power input port of the 9823.
- 3.) Connect the device that user would like to control to the IO of the 9823.
- 4.) After power in for around **60 seconds** , there is a short beep sound for 9823 which means the system reboot successfully

2.2.2.9 Reset & Reboot

- RST : Means Reset , set the device back to manufactory default . Like IP, password, schedule , ping setting and IO setting .

Keep pressing the RST button for 5 seconds and then release, user will get 4 short beeps soon as release the RST button , 4 beeps means the device start setting back to default .

After reset , the device will reboot it selves . So customer will get another short beep (keep pressing for 5 seconds)

The total time of RESET plus reboot procedure is around 65 seconds

- RAT : Means Reboot , device power reboot .It will take 60 seconds to boot up the system

3. System configuration

3.1 Hardware configuration

As mentioned in Page 12 , user will need following items to complete user system hardware configuration.

Minimum system Requirements :

- Windows OS with network capacity & web browser .
Like Google Chrome , Safari , **IE 9.0 or above** .
- Ethernet Hub /Switch (at least 2 ports)
- Ethernet cable with RJ45 connector
- Power supply for IP9823GP-RL (12 ~ 30 VDC unregulated)

3.2 Network Connection :

We suggest to connect 9823GP-RL to user router /switch in the beginning.
For quick log in, we set the default network connect ion for 9823GP-RL as DHCP .

If connect 9823GP-RL to PC directly , the 9823GP-RL will change to our assigned default FIX IP and will not be back to DHCP as power reboot . User will need know the IP of user PC and then change the IP of 9823GP-RL .

Please refer the two connection way to get different IP address :

● **Connection 9823GP-RL with Router / Switch : strongly suggest**

➔ IP 9823GP-RL ---- Router /Switch ----- PC

Please use IPEDIT to get the IP address and 9823GP-RL should get the IP at the same segment with user PC system .

For example : PC IP address is 192.168.100.123
 9823 IP address is 192.168.100.125

As under same segment of user PC and 9823GP-RL , user can login 9823GP-RL by the web browser.

Note : Segment is the first 3 set (192.168.100) IP of full IP address (192.168.100.123)

● **For connection 9823GP-RL to PC directly :**

➔ IP 9823GP-RL ----- PC

The IP will be change to fixed IP .

Default FIXED IP: 192.168.1.168 (While this is no DHCP apparently)

Default Login: admin

Default Password: 12345678

After power on , It will take around 60 seconds to boot up the system . There is a long beep sound means boot up successfully.

3.2 Software configuration

As an embedded web server system , 9823GP-RL work as power on and do no need to install the driver . There is no driver to initial the system. User only need to install the IP address searching software “ IPEDIT “ to find out the IP address of 9823GP-RL in the beginning .

3.2.1 Software installation

The **IP Family CD** comes with the device , it has all the necessary software to run and setup the device.

- IPedit : for search IP address of LAN /WAN in Windows system
- **IP Power Center : for multiple IP Power devices control in one software .**
-

Please refer the following procedure :

1. Place the **IP Family CD** into the CD/DVD Rom drive. The CD will auto run , but if it does not go to the CD/DVD Rom drive and select the “**autorun.html**” file.). If the IE / Google chrome / user default web browser do not auto run , please go to the CD and select the file “ autorun.htm” and open it by user web browser .

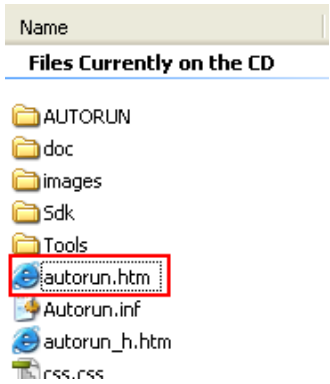

2. Please select the model IP9823GP-RL
3. There are software , manual and QI in this area for download .

Download the software – IP Family and the software shortcut will be on the top of user pc desktop . Click “ ipedit.exe “ .

IP Edit is a search tool designed to search, configure, or access the IP Power device from a local networked computer. Then user can select searched IP address to log in the webpage of IP Power device.

3.2.2 Software overview

IPEDIT is a free search software developed by Aviosys for searing IP address of all IP Power series . User can change the name , gateway , IP address , netmask and two HTTP ports and read the MAC address in this software .

For IP9823GP-RL , please use the version of IPEDIT in package CD .

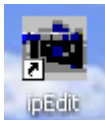

Note : If there is no IP list in the window of local devices area of IPEDIT , please refer the following situation of user connection :

- **The IP 9823 should be under same segment and same router with the PC with IPEDIT program.**
- **Please disable the Firewall and Anti Virus software temporarily in the PC and try again.**
- **There might be two Network working on the PC system , like two LAN cards , please disable one for IPEDIT to search the 9823GP-RL .**

Double click the IP address of 9823GP-RL in IPEDIT and the PC will execute web browser like IE or Google Chrome and there is wizard pop up to enquire the Username and Password .

Username : admin

Password : 12345678

Use can change the IP address information of 9823 .

- 1.) In the local devices section user will see user device show up if connection correctly.
- 2.) Select the 9823 device and the device information will pop up on the right.
- 3.) Check to see that the gateway IP and the IP Address (9823) match user current network.

If not, type in the correct information, then hit the submit button to save changes.

For example:

If user have the following information regarding the 9823 and user network

User PC Network :

Computer IP Address:	192.168.1.122	Gateway:	192.168.1.1
Sub Net mask:	255.255.255.0	Port:	80

User 9823 in IPEDIT :

9823 IP Address:	192.168.100.34	Gateway:	192.168.100.1
Sub Net mask:	255.255.0.0	Port:	80

[Since the IP Address of the 9823 is : 192.168.100.34

User will need to make sure that the first 3 segments of user 9823 IP Address must match the first 3 segments of user gateway IP.

First 3 Segment of Gateway Address: 192.168.1.X

So user new IP Address for the 9823 should be: 192.168.1.XXX

New Network Information

9823 IP Address: 192.168.1.26

Gateway Address: 192.168.1.1

Local Computer IP Address: 192.168.1.122

Sub Net mask: 255.255.255.0

Port: 80

- 4.) Press the " Rescan " button to see if changes have been made.
- 5.) Double click on the device in the local device section and an IE web browser with the device login will pop up.
- 6.) Type in the default Login and IP Address to enter the device.

Default Login : admin

Default : 12345678

Notice : User can click " REF " in IEPDIT to auto search proper IP setting for 9823.
It will take few minutes to show the suggest wizard.

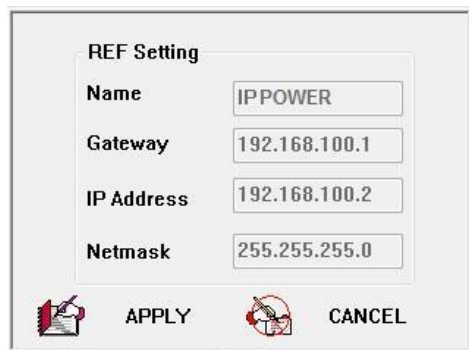
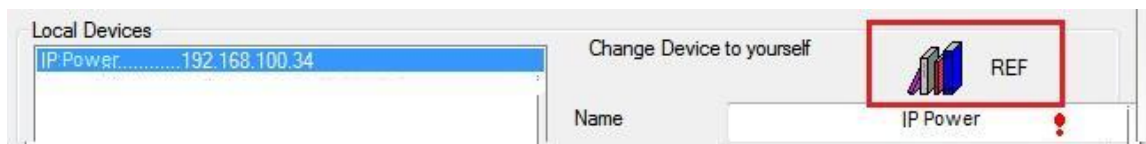

Please click " APPLY " as seeing the suggest wizard , click " yes " to ignore the remind message of IP being used and then type the Username and Password to change the IP setting. Username : admin Password : 12345678

Notice :

Segment : The first 9 digits of the IP Address .

EX: The IP of user PC is 192.168.100.122. If the " Local IP Address " at WiFi Info is 192.168.100. x (X can the value of 1~252) , user PC can get into the webpage of 9823 .

Please press "Rescan " to search the router near by again if can not see user router in the list.

3.2.3 Using IP Service (& CNT)

IP Service is a function which allows user to search for the device easily without having to remember long complicated IP address. Instead, if user know the device's name of user IP Power device and user can easily find IP Address with IP Service. **To log in the webpage of 9823 on Internet , user still need to do the "Port Forwarding " in own router.**

Before using "IP Service " , please change the device name of user 9823 to avoid similar name in Host Server.

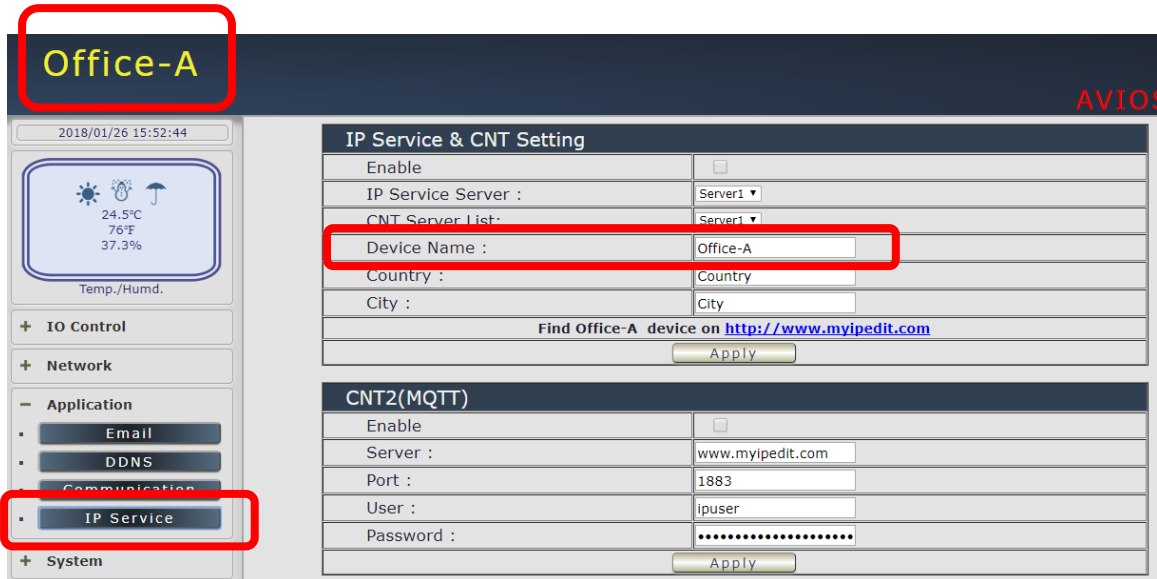

1.) Open software " IPEdit " and select the server that user's 9823 is designated to.



2.) Hit the Green Connect button on the top of IP Edit.

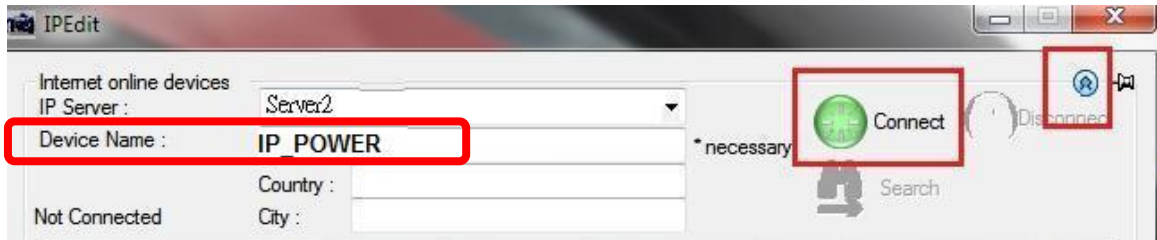

3.) Then type in the 9823 Name that user have selected for the device and press the Search button.

4.) Find user device and double click on the screen and a IE window will pop up connecting to user device.
**User device must be Port Forwarded for the login screen to appear.*

EX: The 9823 device name as IP_POWER , and user can search the device easily :

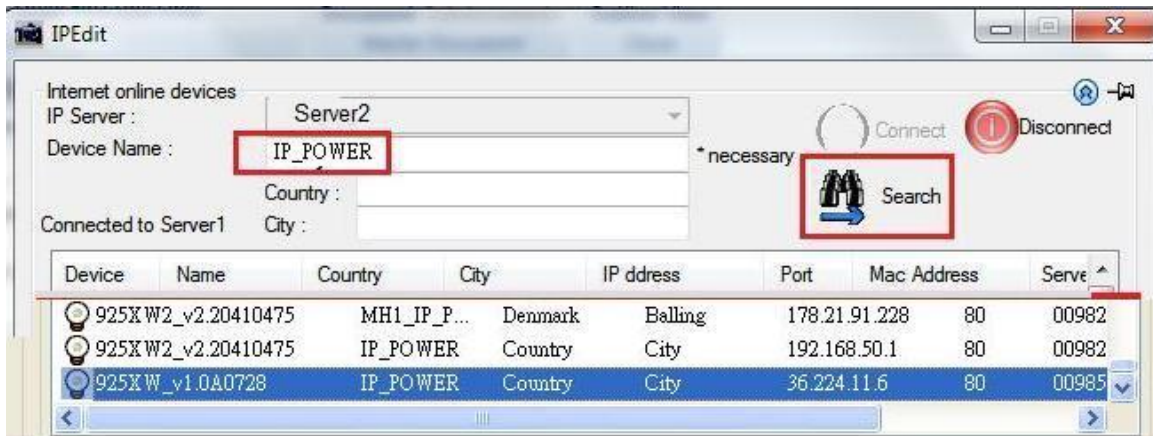

5.) After user have connected to user device, type in the Login and Password for user device

3.3 Internet Setup

To connect the IP Power 9823 on Internet, there are two ways

- Setup Port Mapping / Port Forwarding in user router. Please check user Router owner's manual .
- Use our own software " IP Power Center " : Please refer to the "IP Power Center " manual in the CD
- Use "UPNP "

User can enable or disable the function .

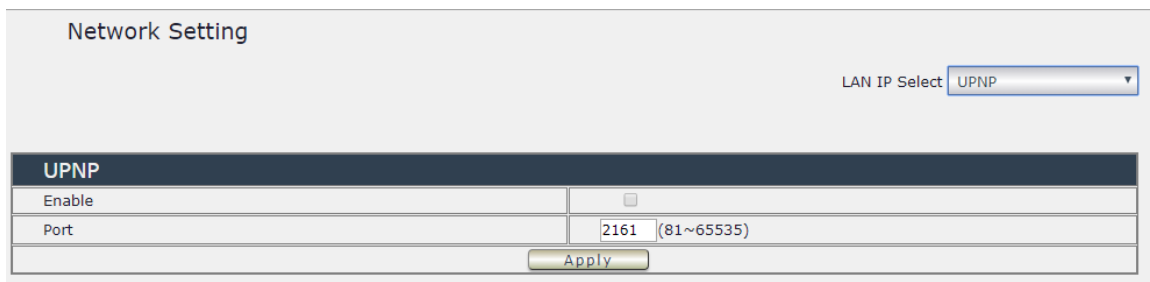

4 Webpage Interface overview

The 9823GP-RL webpage offers a graphical interface that helps user configuration . It is also very convenient to test and monitor user remote data acquisition and control system. The following guidelines will give user some brief instructions on how to use this device .

The configuration column at the left side of the Web Interface are the functionality and setup of the IP Power 9823GP-RL .

There are 5 areas :

- **Information** : Device Name , Display , Time and Humidity & Temperature status
- **IO Control** : DI-DO , Schedule & Ping.
- **Network** : Setting
- **Application** : Email , DDNS, Communication & IP Service
- **System** : Management, Information, SysLog & Firmware
- **Logout**



4.1 Information

4.1.1 Device Name :

The device name show in yellow at the left side of webpage . User can change the name in Application → IP Service → Device name

Please change the name in English only and do not use other symbols like !@#%\$^&*()_+

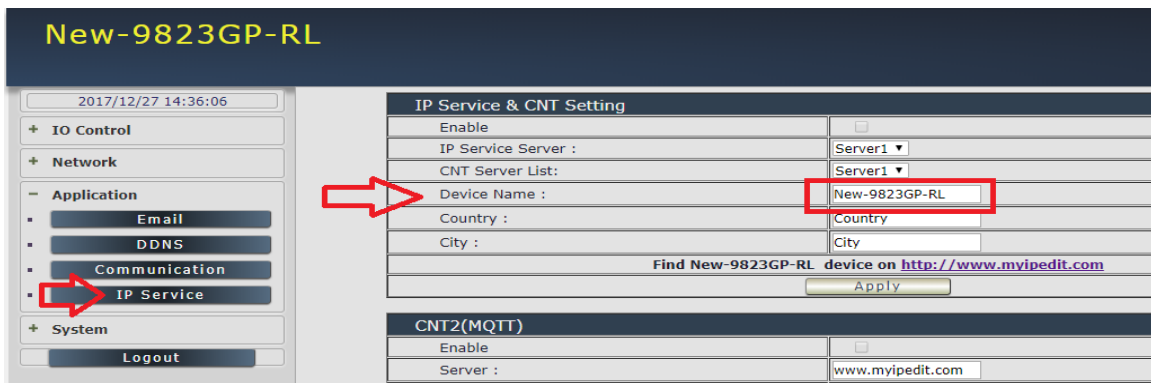

4.1.2 Display

Click any part of the deep blue column can hide or display the configuration column. This design is for small display like smart phone .

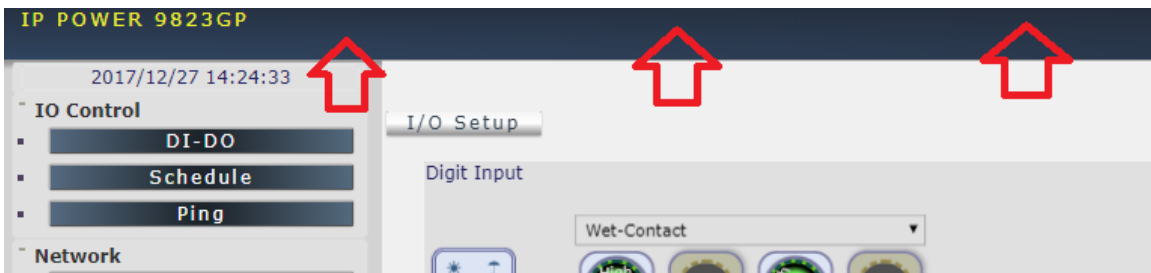

Normal - with full display / Without configuration column



4.1.3 Time

User can get Time at Year – Month – Date Hours : Minutes : Seconds here .



To setup the Time , Please go to “ System → Management → NTP Settings “ , there are several ways to setup the time .

NTP Settings	
Date	02 / 09 / 2018 (MM/DD/YY)
Time	13 : 12 : 20 (HH:MM:SS) <input type="button" value="Apply"/>
Current Time	Fri Feb 9 13:12:19 GMT 2018 <input type="button" value="Sync with local time"/>
Time Zone	(GMT+0800)ChinaCoast,HongKong
NTP Server	pool.ntp.org ex: time.nist.gov
Sync with NTP	Every 1 hours <input type="button" value="Apply"/> <input type="button" value="Cancel"/>

4.1.4 Humidity & Temperature status

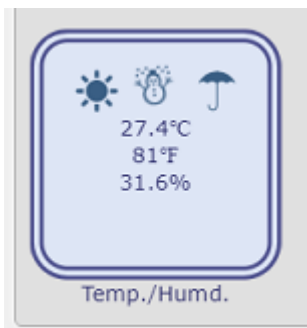

There is a Humidity & Temperature sensor on 9823GP-RL board shows the temperature value in Celsius (°C) and Fahrenheit (°F) and the Relative humidity (%)

Sensor Range :

Temperature : -20 ~ +60 °C or -4 ~ +136 °F

Humidity : 20 ~ 95 % RH

4.2 IO Control

The IO Control Section allows user to directly or automatically get the status of DI , control the Relay or the DO , setup the Schedule for the Relay or the DO , setup the Ping function of Relay outlets .

There are 3 sections : DI-DO , Schedule & Ping .

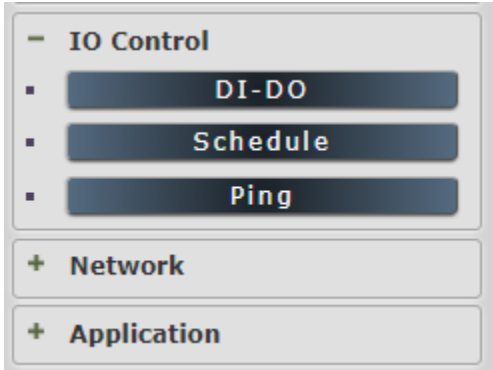

4.2.1 DI-DO

In this area , user can control& setup the IO - Relay , DI and , DO by select the button “ IO Control “ or “ IO Setup “

4.2.1.1 IO Control

Here user can get the status of DI Sensors and control the DO-Relay and the DO .

A. Relay

There are 4 Latching Relay outputs in IP Power 9823GP-RL . Each relay can be controlled ON , OFF or Reboot individually .

Latching relay is Low power dispassion, lower spike and no heat. It is more durable than other normal relay . Latching relay is also a memorable relay . As the device power turn off , the relay status will keep as it is at ON or at OFF.



There are two operations for controlling the relay :

A-1 Manual control : Control each port ON or OFF directly by pressing the power button.

A-2 Power Cycle control : Manually Control the relay delay to turn ON / OFF . The relay cycle time can be set from 1 to 9999 seconds



User can setup the time and the final status in power cycle as ON / OFF

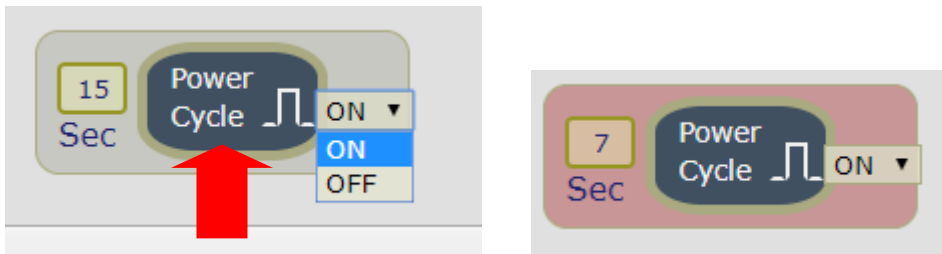

For example : (sec = seconds)

- Original Outlet as " OFF " , select final status as " ON " & fill 15sec :
After press power cycle button, the outlet will turn OFF for 15 seconds and then turn ON .

OFF (15 sec) → ON

- Original Outlet as " ON " , select final status as " ON " & fill 10sec :
After press power cycle button, the outlet will turn OFF for 10 seconds and then turn ON .

ON -- > OFF (10 sec) → ON

- Original Outlet as “ OFF “ , select final status as “ OFF “ & fill 8 sec :
After press power cycle button, the outlet will turn ON for 8 seconds and then turn OFF .

OFF → ON (8 sec) → OFF

- Original Outlet as “ ON “ , select final status as “ OFF “ & fill 5 sec :
After press power cycle button, the outlet will be ON for 5 seconds and then turn OFF .

-

ON (5 sec) → OFF

Notice :

As use Latching Relay in IP 9823 , there is no difference of **Normal Closed Relay** (NC) or **Normal Open Relay** (NO) . As there is no power for 9823 device , **the relay status will keep as it is at ON or at OFF .**

B. Digit Input (DI)

There are 4 normal DI and 2 special DI in IP9823GP-RL .

B-1 Normal DI : 4 normal DI for Dry Contact or for Wet Contact

Dry contact means normal contact (shorting link) .

WET contact means the sensor is providing or passing some voltage or current to .



Note : We design the 4 standard DI for 9823 to use as all DRY contact or all Wet contact .

B-2 Special DI :

Support 2 special DI : In DI5 & DI6 , they support 4 kinds of sensors :
DC Input , DC Input Falling Edge , Tachometer and Tally Counter

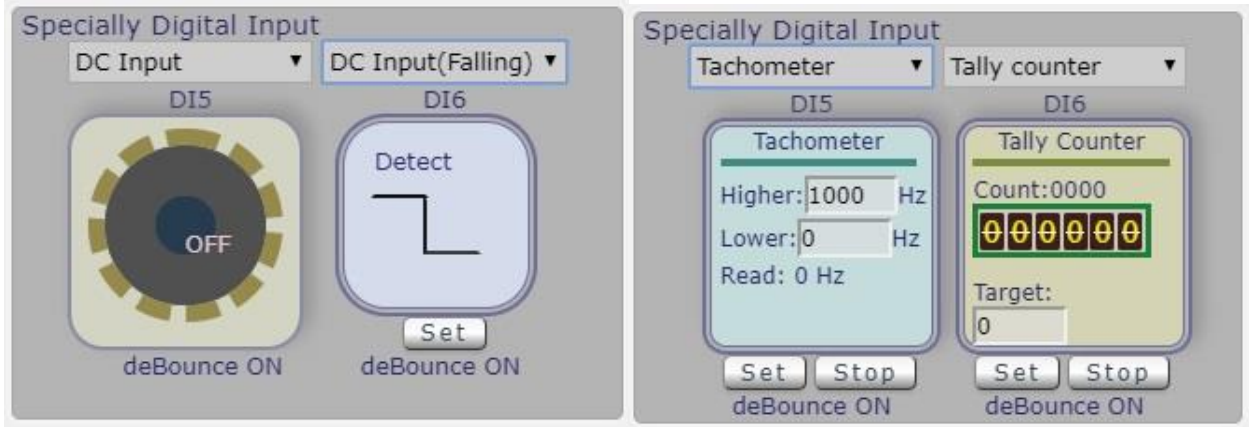

- DC Input : Dry contact or Wet contact
- DC Input (Falling Edge) : **As select this function , Please Do press SET as enable .**
- Tachometer : Can setup the lower and higher Hz range at 0 to 1000 Hz .
- **As select this function , Please Do press SET as enable .**
- Tally Counter : Range Setup
As select this function , Please Do press SET as enable .

C. Digit Output (DO)

There are 4 digital outputs (DO) in 9823GP-RL . Each DO is a programable output :
COM power voltage is up to 50V, open drain design. Provide 4 type 400ma pull down
output.



- DO # 1 : Support DC Output , Pulse Output , Frequency Output & PWM output
- DO # 2 , 3 & 4 : Support DC Output , Pulse Output , Frequency Output

- DC Output : Control ON or OFF by press the button directly .

- Pulse Output :

Down counter range : from 0 to 999999 seconds

The period range of Pulse is 0.5 ms to 2s (ms = mini second / s = second)
It can be setup in I/O Control Page .

Setup Period range : Go to " I/O Setup " page by click " I/O Control " button

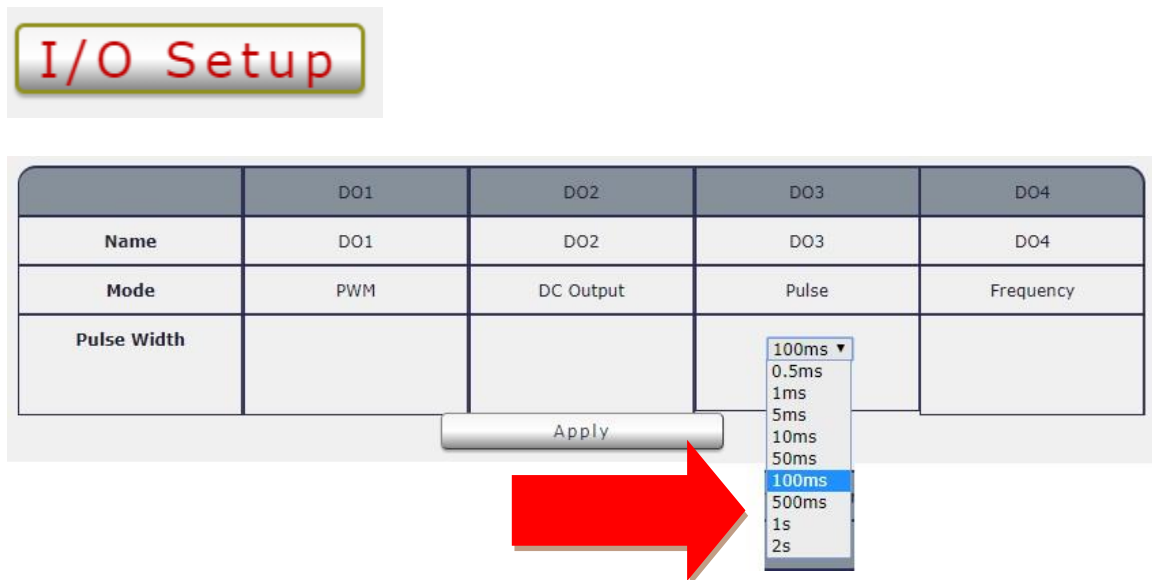

- Frequency Output : supply 1 ~ 1000 Hz Frequency out.

- PWM Output : PWM (pule width modulate) output . Only support in DO #1
Frequency support range : 1K ~ 10K Hz
Width support range : 0 ~ 99 (based on 10 times)

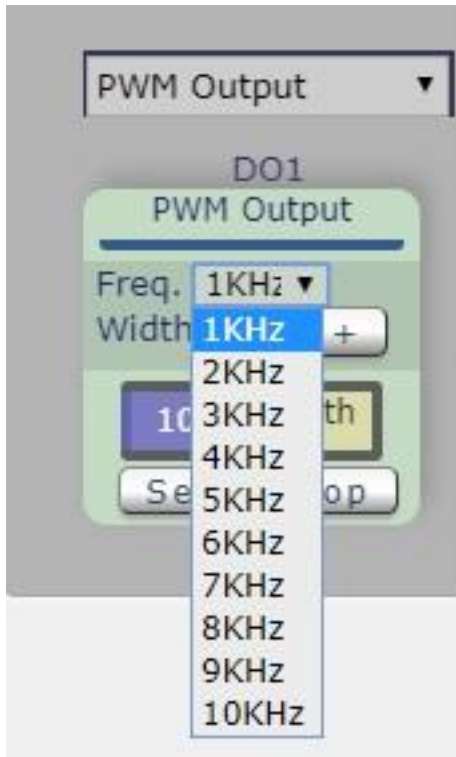

4.2.1.2 IO Setup :

User can do the advance setup in Relay , DI , DO , setup “ Wake on Lan “ or “ Shutdown on Lan “ :

- In Relay : Name , mode , Alarm (Email / Beep) and Default Power status .
- IN DI : Name , mode , Alarm (Email / Beep) , Event Action and Notice .
- In DO : Name , mode and Beep Alarm
- Wake On Lan
- Shutdown On Lan

O Name setting

User can name each power by click the name above the power button

The number of character is max. 12 characters and Please change the name in English only and do not use symbol like !@#\$%^&*()_+

A. In Relay :

	Relay1	Relay2	Relay3	Relay4
Name	power1	power2	power3	power4
Mode	Toggle ON/OFF	Toggle ON/OFF	Toggle ON/OFF	Toggle ON/OFF
Beep Notice	OFF ▾	OFF ▾	OFF ▾	OFF ▾
Email Notice	OFF ▾	OFF ▾	OFF ▾	OFF ▾
Power ON	OFF ▾	OFF ▾	OFF ▾	OFF ▾

Apply

A-1 Name : Please change the name in English only and do not use symbol like !@#\$%^&*()_+

192.168.100.136 顯示 :

Please enter Relay21 name:

tony

確定 取消

	Relay1	Relay2	Relay3	Relay4
Name	Jason	tony	power3	power4

A-2 Mode : Show the status of the IO

A-3 Beep Notice : As the relay turn on or turn off , the beeper will alarm.

A-4 Email Notice : To use this function , please fill email information in “ Email “ area under “ Application “ Please refer the setting information in page #56

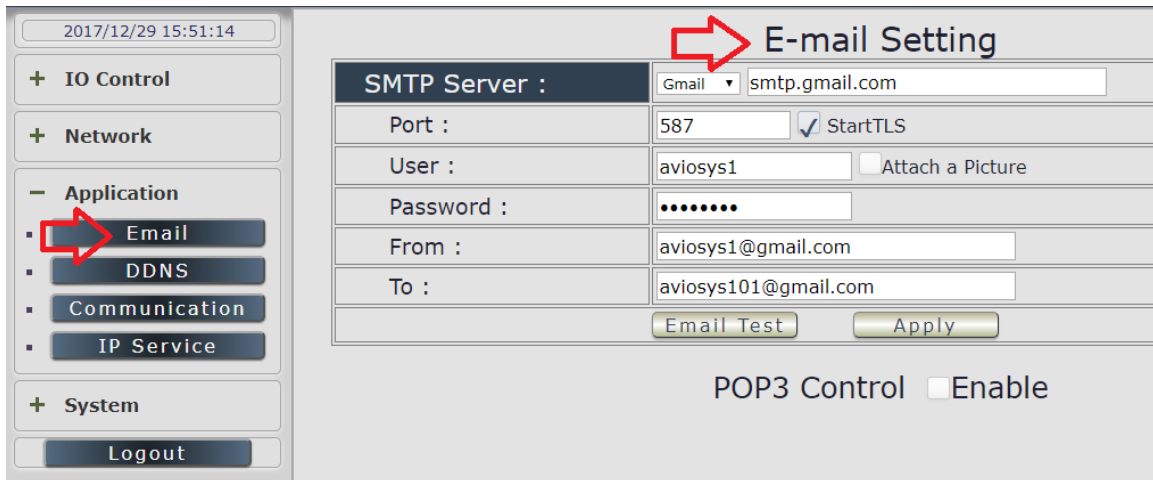

A-5 Power ON

Here is to setup the default power status as device power reboot .

The control section allow user to set the power status on ON or OFF or LAST when the device power Rebooted . The output will be same status as choose LAST before the device power turn off. To save the setting here , please click “Apply “ button .

Notice :

As use Latching Relay in IP 9823GP-RL , there is no difference of **Normal Closed Relay** (NC) or **Normal Open Relay** (NO) . As there is no power for 9823 device , **the relay status will keep as it is (ON / OFF)** .

B. In DI :

DI 1 , 2 , 3 & 4 : The 4 DI are stand . Support Dry / Wet Contact .

DI 5 & 6 : The two DI

	DI1	DI2	DI3	DI4
Name	DI1	DI2	DI3	DI4
Mode	Edge Triggered	Edge Triggered	Edge Triggered	Edge Triggered
Beep Notice	OFF ▾	OFF ▾	OFF ▾	OFF ▾
Email Notice	OFF ▾	OFF ▾	OFF ▾	OFF ▾
Event Action	Undo ▾	Undo ▾	Undo ▾	Undo ▾
Notice	Event Repeat: None ▾	Event Repeat: None ▾	Event Repeat: None ▾	Event Repeat: None ▾

Apply

	DI5	DI6
Name	DI5	DI6
Mode	DI Disable	DC Input(Falling Edge)
Bounce filter	ON ▾	ON ▾
Beep Notice	OFF ▾	OFF ▾
Email Notice	OFF ▾	OFF ▾

Apply

B-1 Name : Please change the name in English only and do not use symbol like !@#\$%^&*()_+



B-2 Mode : Show the status of the IO

B-3 Beep Notice : As the DI statu change , the beeper will alarm.

B-4 Email Notice : To use this function , please fill email information in “ Email “ area under “ Application “ Please refer the setting information in page # 56

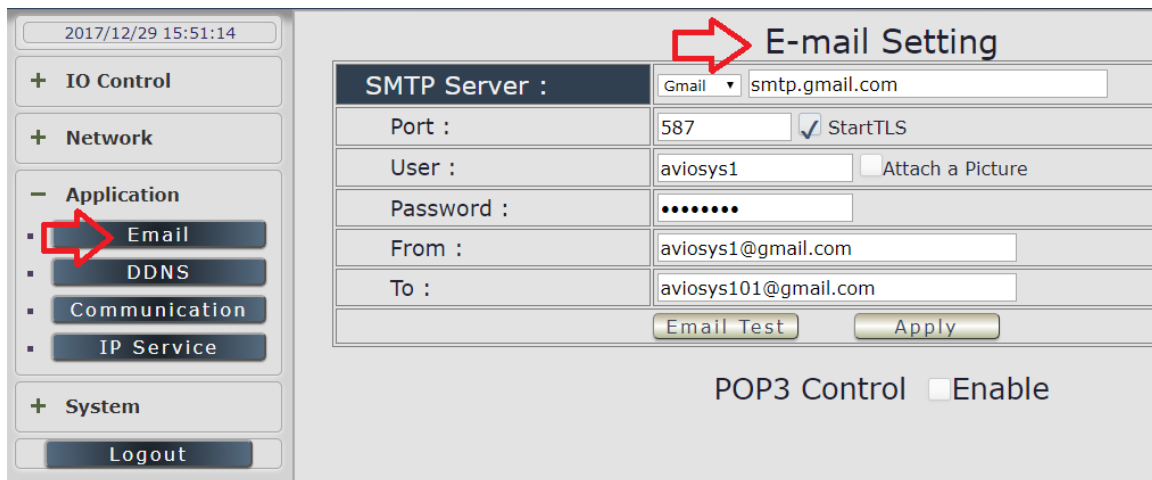

B-5 Event Action : For DI 1 , 2 , 3 & 4 only .

One DI can trigger one Relay .

Use can trigger Relay ON /OFF /Cycle as the assigned DI Rising edge .

Like Relay Disconnect , connect or cycle (from Off →On , Or from On→Off→On)

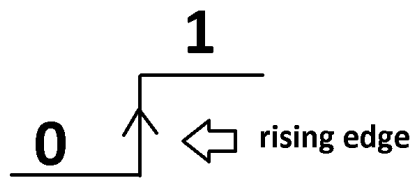

Event Action	Undo
Notice	Event
	<ul style="list-style-type: none"> Undo RL1 RL1 Disconnect RL1 Connect RL1 Cycle RL2 RL2 Disconnect RL2 Connect RL2 Cycle RL3 RL3 Disconnect RL3 Connect RL3 Cycle RL4
Name	
Mode	

B-6 Notice : For DI 1 , 2 , 3 & 4 only . The event action can set as one time or always .

Event Repeat:	None
	<ul style="list-style-type: none"> None 1 times 2 times 3 times always

B-7 Bounce filter : only In DI #5 & 6 , User can Enable or disable the filter

C. In DO :

C-1 Name

Please change the name in English only and do not use symbol like !@#%&*()*_+



C-2 Mode : Show the status of each IO

C-3 Pulse

The period range of Pulse is 0.5 ms to 2s (ms = mini second / s = second)

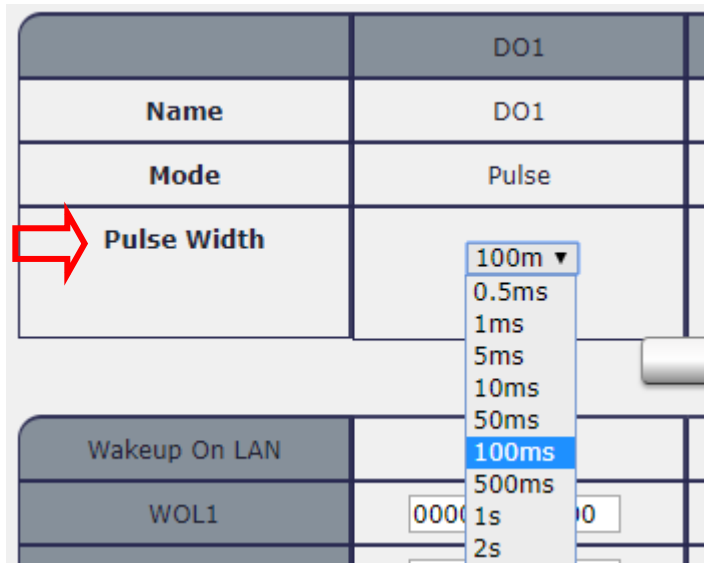

D. Wake On Lan :

Remote Wake up PC by MAC address in Ethernet (LAN) . Use Network port (RJ45), you can wake PC on WAN by PC `s MAC address.

Wake on LAN (WOL) premise:

- (1) First the PC mother board needs to have Wake on LAN support and enable this WOL function in the BIOS setting.
- (2) User`s network card must also support “WOL”, remember to connect your connect cable to Mother board or the network card cannot send the “power on” message to the motherboard.

After both the motherboard and network card have been setup, you can use WOL function by following the steps below:

Step 1: Log in 9258 web page and go to “Network Wakeup”

Step 2: Type in your MAC address then press “send” – the PC will be power ON.

Wakeup On LAN	MAC	Wakeup
WOL1	<input type="text" value="000000000000"/>	<input type="button" value="Send"/>
WOL2	<input type="text" value="000000000000"/>	<input type="button" value="Send"/>
WOL3	<input type="text" value="000000000000"/>	<input type="button" value="Send"/>
WOL4	<input type="text" value="000000000000"/>	<input type="button" value="Send"/>
WOL5	<input type="text" value="000000000000"/>	<input type="button" value="Send"/>
WOL6	<input type="text" value="000000000000"/>	<input type="button" value="Send"/>
WOL7	<input type="text" value="000000000000"/>	<input type="button" value="Send"/>
WOL8	<input type="text" value="000000000000"/>	<input type="button" value="Send"/>

E. Shut Down On Lan

Shut Down On Lan : Support Windows or Linux version . Setting of software shut down controlled PC/ Server

IP9823GP-LT can be used to safely turn off the PC/Server through Network. With this feature user can remotely shutdown any PC/ Server which that is connected to the IP 9823GP-RL through normal Windows shut down procedure.

Documents created in programs like Microsoft office will not be automatically saved. The IP9823GP-RL will still shutdown the controlled PC/server without saving the file. The controlled PC/Server must be in the same ETHERNET and the same SUBNET as the 9823GP-RL .

User can setup the delay time for the Relay to turn OFF after SOL command place by 9823GP-RL . The delay time is working for SOL1 ~ 4 (Relay 1 ~ 4) only .

Shutdown On LAN	DelayTime
SOL1	<input type="text" value="60"/> Seconds
SOL2	<input type="text" value="60"/> Seconds
SOL3	<input type="text" value="60"/> Seconds
SOL4	<input type="text" value="60"/> Seconds
SOL5	<input type="text" value="60"/> Seconds
SOL6	<input type="text" value="60"/> Seconds
SOL7	<input type="text" value="60"/> Seconds
SOL8	<input type="text" value="60"/> Seconds

Before operating the software shutdown function it is essential to install our software:

Installing and Setup of the “PowerOFFDelayConfig .exe”:

1. Insert the CD that came with the device into the PC that you want to turn off.
2. Please download the software in our attached CD : SDK → Shut Down On Lan → PowerOFFDelayservice.zip and unzip the software and install program “PowerOFFDelayConfig.exe “ into the PC that will be controlled.
3. Execute and fill correct information in each section :

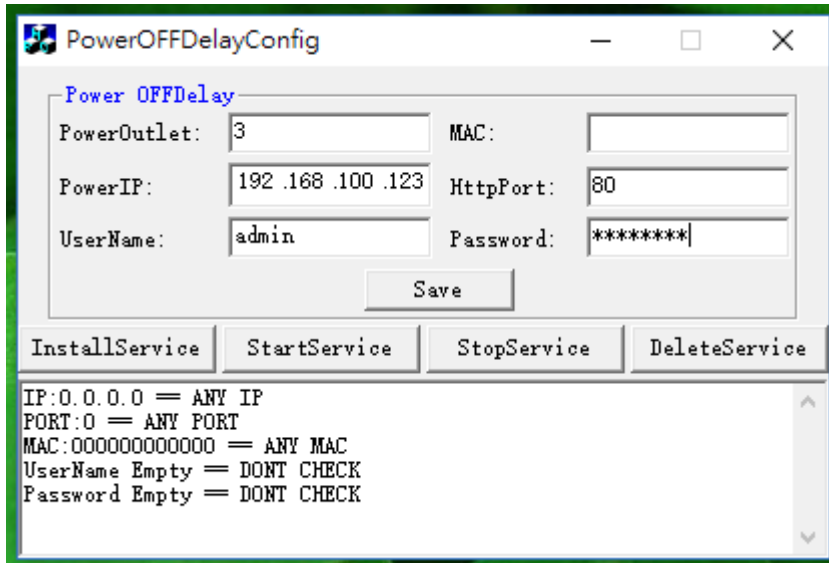

- PowerOutlet : Enter the power number in the 9823GP-RL that user want to control
- MAC : Enter the MAC address of the 9823GP-RL
- Power IP : Enter the IP address of the 9823GP-RL.
- HttpPort: Fill the port of 9823GP-RL , default value is 80, if amend the port in 9258 please correct.
- UserName:** admin
- Password:** 12345678 (password can amend in web page)

- a.) Click “**Save** “ to save the settings.
- b.) Then Click “**InstallService**” to install.
- c.) Then “**StartService**” then please shutdown the PC/Server.
After the PC has been restarted, the function will be in effect.

4.2.2 Schedule

In this section , user can see the setting schedule list first up to 29 rules . To setup each schedule , please press “ Schedule Setting “ , then user can get the “ Schedule List “ page as following :



After setup the first schedule , the second schedule will pop up automatically in the Schedule list for user to setup new one . Use can add 29 rules one by one . Each rules can control 1 pc to 4 pcs Relay and 1pc to 4pcs DO .

4.2.2.1 In “ Schedule list”

User can see the schedule user apply and the information .

The screenshot displays the "Schedule Setting" interface. At the top right, there is a "Schedule Setting" button. Below it, the text "WOL=Wake-On-Lan, SOL=Shutdown-On-Lan" is visible. The interface shows three rows of schedule settings, each with a "No." label, a date range, a "Schedule" box with an action time, and a control panel with buttons for "Relay CYCLE" and "DO-ON".

No.	Date Range	Schedule Action	Control Panel
No.1	On 2018/01/02	Schedule Action at 15:50:00	Relay CYCLE 1, Relay CYCLE 2
No.2	From 2018/01/02 To 2018/01/05	Daily Schedule Action at 15:44:00	DO-ON 3, DO-ON 4, Relay CYCLE 3, Relay CYCLE 4
No.3	On 0000/00/00	Schedule Action at 00:00:00	(Empty control panel)

4.2.2.2 In “ Schedule Setting “

A. Action :

The schedule allows user to control the DO and Relay outlet or turn ON , OFF , Cycle (Off to ON) at assigned time

-In Relay : ON, OFF , CYCLE , WOL (Wake on Lan) or SOL (Shutdown on Lan)

-In DO : WOL (Wake on Lan) , SOL (Shutdown on Lan) ,ON or OFF .

- **WOL (Wake on Lan)** : Please refer the page 43 . WOL is for 9823GP-ERL to send WOL command to WIN /LINUX OS to boot up **as that OS is power OFF status** (not freeze status) The OS mother board need to support WOL function .

Relay Outlet #	WOL #
1	1
2	2
3	3
4	4

DO Outlet #	WOL #
1	5
2	6
3	7
4	8

Wakeup On LAN	MAC	Wakeup
WOL1	<input type="text" value="000000000000"/>	<input type="button" value="Send"/>
WOL2	<input type="text" value="000000000000"/>	<input type="button" value="Send"/>
WOL3	<input type="text" value="000000000000"/>	<input type="button" value="Send"/>
WOL4	<input type="text" value="000000000000"/>	<input type="button" value="Send"/>
WOL5	<input type="text" value="000000000000"/>	<input type="button" value="Send"/>
WOL6	<input type="text" value="000000000000"/>	<input type="button" value="Send"/>
WOL7	<input type="text" value="000000000000"/>	<input type="button" value="Send"/>
WOL8	<input type="text" value="000000000000"/>	<input type="button" value="Send"/>

- **SOL (Shutdown on Lan)** : Please refer the page 44. SOL is for 9823GP-ERL to send SOL command to the WIN OS which execute our software “ **PowerOFFDelayConfig.exe** ” to shut down up **as that OS is On status** (not freeze status) The OS mother board need to support WOL function .

Note : There is LINUX version software for Shutdown on Lan

Relay Outlet #	SOL #
1	1
2	2
3	3
4	4

DO Outlet #	SOL #
1	5
2	6
3	7
4	8

Shutdown On LAN	DelayTime
SOL1	<input type="text" value="60"/> Seconds
SOL2	<input type="text" value="60"/> Seconds
SOL3	<input type="text" value="60"/> Seconds
SOL4	<input type="text" value="60"/> Seconds
SOL5	<input type="text" value="60"/> Seconds
SOL6	<input type="text" value="60"/> Seconds
SOL7	<input type="text" value="60"/> Seconds
SOL8	<input type="text" value="60"/> Seconds

B. Adding a Scheduled Event

First , Select the Action Duration : There are 3 setting - Once , Every Day . Every Week

Second ,Select a Specific Date Range where the device will repeat the desired actions during the time specified.

Clear		Today														Close								
<Prev		November 2013							December 2013							January 2014							>Next	
Su	Mo	Tu	We	Th	Fr	Sa	Su	Mo	Tu	We	Th	Fr	Sa	Su	Mo	Tu	We	Th	Fr	Sa				
3	4	5	6	7	8	9	8	9	10	11	12	13	14	5	6	7	8	9	10	11				
10	11	12	13	14	15	16	15	16	17	18	19	20	21	12	13	14	15	16	17	18				
17	18	19	20	21	22	23	22	23	24	25	26	27	28	19	20	21	22	23	24	25				
24	25	26	27	28	29	30	29	30	31					26	27	28	29	30	31					

Third , Select the Time Period.

Forth , Choose the Action : Enable # by clicking in the small square to mark “ v ” , and select one from the power action of OFF/ON/RESET / WOL /SOL as user need .

Relay Action

<p style="text-align: center;">Jason <input checked="" type="checkbox"/></p> <p>Relay-CYCLE ▼ 000 sec.</p>	<p style="text-align: center;">tony <input checked="" type="checkbox"/></p> <p>Relay-CYCLE ▼ 000 sec.</p>	<p style="text-align: center;">power3 <input type="checkbox"/></p>	<p style="text-align: center;">power4 <input type="checkbox"/></p>
---	--	---	---

DO Action

<p style="text-align: center;">power5 <input checked="" type="checkbox"/></p> <p>DO-OFF ▼ WOL SOL DO-ON DO-OFF</p>	<p style="text-align: center;">power6 <input type="checkbox"/></p>	<p style="text-align: center;">power7 <input type="checkbox"/></p>	<p style="text-align: center;">power8 <input type="checkbox"/></p>
---	---	---	---

Once the scheduler has been Set Up , hit the “ Apply No.X Sch “ button and user will see user setting located on the bottom of the Action section .

C. Edit a Schedule Event :

Step1 : Please select the Rule user want to edit in Scheduler List .

Step2 : Change the setting like Duration , Date , Time and Action.

Step3 : Press “ Apply NO. X Sch “ button to save the setting and user will see the page refresh and new setting display in Scheduler list

D. Delete - Click “ Delete “ button to remove a rule form the list .

4.2.3 Ping

The Ping function allows the device to Ping an IP Address automatically to act as a watchdog to make sure the device getting Ping and working properly. Please Click the button to switch between “ Ping Setting “ & “ Ping List “ .

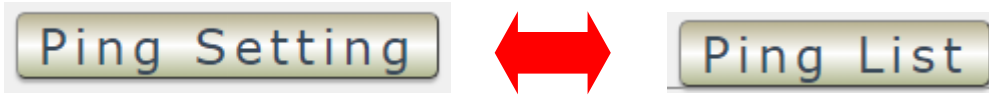

4.2.3.1 Ping List

Here list out the 8 Ping List for user to check . As click any part of the gray column , user can go to the setting of that Ping number . **There are 8 rules in Ping list** User can setup 8 Ping rules . Each rules can control 4pcs Relay and 4pcs DO automatically .

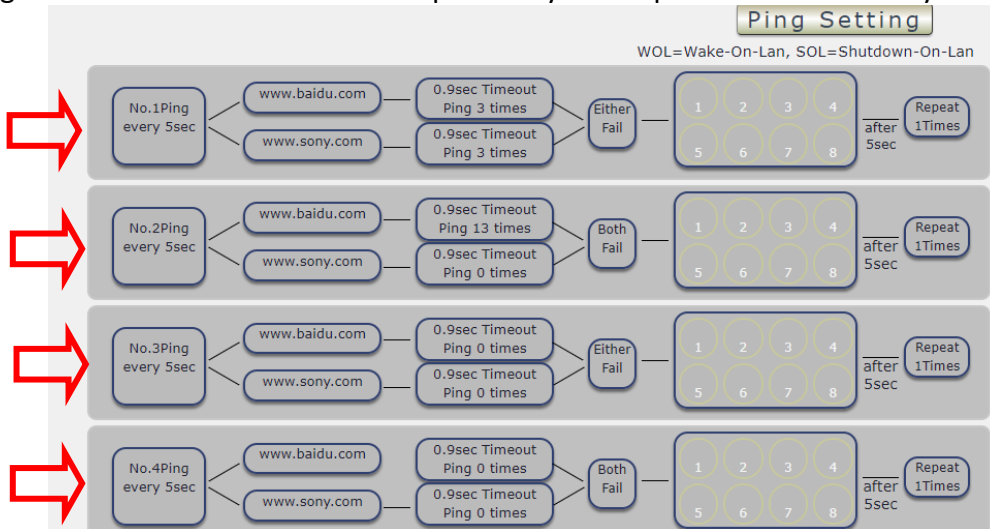

4.2.3.2 Ping Setting

User can click to select different rules numbers at the right side button “ Rule No: X “ as following pictures . There are 8 rules available.

The screenshot shows the 'Global Ping Base Setting' interface. At the top right is a 'Ping List' button. The main section is titled 'Global Ping Base Setting' and contains an 'Apply' button. Below this are several input fields: 'Ping Interval' (5 Sec.), 'Response Time Out' (900 ms.), 'Ping After Action Delay' (5 Sec.), and 'Action Max repeat times' (1 (0=non stop)). There are radio buttons for 'Conditional Mode' with 'Single' selected and 'OR' highlighted in green. Below this is a table with columns for 'IP & Host Name', 'Check', 'Failed times then action', and 'Repeat'. The first row shows 'www.baidu.com' with a 'Check' button, '03' failed times, and a 'Repeat' dropdown set to 'Stop'. The second row shows 'www.sony.com' with a 'Check' button, '03' failed times, and a 'Repeat' dropdown set to 'Stop'. A red box highlights a 'Rule No1' button on the right side of the table. Below the table are 'Apply Rule' and 'Delete' buttons. At the bottom, there is a diagram titled 'Ping 1' showing a flow: 'No.1 Ping every 5sec' leads to two hosts, 'www.baidu.com' and 'www.sony.com', each with a '0.9sec Timeout Ping 3 times' box. These lead to an 'Either Fail' box, which then leads to a grid of 8 numbered buttons (1-8) representing rule numbers. A 'Repeat 1Times after 5sec' box is also shown.

There are 3 sections of the area :

A. Global Ping Base setting :

This screenshot shows the top section of the 'Global Ping Base Setting' interface. It includes a 'Ping List' button at the top right. The main section is titled 'Global Ping Base Setting' and contains an 'Apply' button. Below this are several input fields: 'Ping Interval' (5 Sec.), 'Response Time Out' (900 ms.), 'Ping After Action Delay' (5 Sec.), and 'Action Max repeat times' (1 (0=non stop)).

- Ping Interval (Sec): The number of seconds between each ping .
- Response Time Out : It is the milliseconds (ms .) of the device will wait for a response from the Pinged device if no ping is detected within this time it will be considered a Ping failure.
- Ping After Action Delay : It is the seconds it take AFTER the action .
- Action max. repeat Times : It is the times to execute the Ping Failure action .Set “ 0 “ means action non stop - Keep action & no limit times.

As finish setting , please click “ Apply “ to save the setting in this area , the webpage will refresh and user can see the final setting result.

B. Conditional Mode :

Conditional Mode			
IP & Host Name		Failed times then action	Repeat
www.baidu.com	<input type="button" value="Check"/>	03	Stop ▼
www.sony.com	<input type="button" value="Check"/>	03	

Rule No1

B-1 Basic setting :

-IP & Host Name : Input the IP Address (ex: 122.116.123.138) or Host - web address (ex: www.google.com) user would like to Ping.
 User can use the “ ping test “ bottom to check the address valid or not

-Failed times then action : Setup the ping failure times for 9823 to execute the setup ON/OFF / Reset action of setting .

-Repeat : After the ON/OFF/Reset action , user can setup the Ping action to keep ping (Continue) or to Stop Ping (Stop) .

B-2 Three Modes

User can select the action activate by one / two IP Host failure or either one fail

- **Single Mode :** Execute Action by one IP Host failure . 9823 will Ping one IP address. As the IP fail times reach to the setting times . Action (ON/OFF/RESET) will be activated .

Conditional Mode			
IP & Host Name		Failed times then action	Repeat
www.baidu.com	<input type="button" value="Check"/>	03	Stop ▼

Rule No1

Ping failure action

- **OR Mode :** Execute Action by either one IP Host failure as setting 2 pcs IP Host . 9823 will Ping 2 IP address. Either one IP fail times reach to the setting times. Action (ON/OFF/RESET) will be activated .

Conditional Mode			
IP & Host Name		Failed times then action	Repeat
www.baidu.com	<input type="button" value="Check"/>	03	Stop ▼
www.sony.com	<input type="button" value="Check"/>	03	

Rule No1

- And Mode : Execute Action by both IP Host failure as setting 2 pcs IP Host 9823 will Ping 2 IP address. Both IP fail reach to the setting times. Action (ON/OFF/RESET) will be activated.

Conditional Mode				
		Single	OR	<input checked="" type="radio"/> And
IP & Host Name	Failed times then action	Repeat	Rule No1	
www.baidu.com <input type="button" value="Check"/>	03	Stop ▼		
www.sony.com <input type="button" value="Check"/>	00			

C. Ping failure action :

In the selected Rules number , please select the outlet number power to activate as ping fails and then press “ Apply Rule Action “ button to confirm the setting .

Ping failure action

Relay Action

Jason <input checked="" type="checkbox"/> Relay-OFF ▼	tony <input checked="" type="checkbox"/> Relay-OFF ▼	power3 <input checked="" type="checkbox"/> Relay-OFF ▼	power4 <input checked="" type="checkbox"/> Relay-OFF ▼
--	---	---	---

DO Action

power5 <input checked="" type="checkbox"/> Relay-CYCLE ▼ 010 sec.	power6 <input checked="" type="checkbox"/> Relay-CYCLE ▼ 010 sec.	power7 <input checked="" type="checkbox"/> Relay-CYCLE ▼ 015 sec.	power8 <input checked="" type="checkbox"/> Relay-CYCLE ▼ 015 sec.
--	--	--	--

Ping failure action

Jason

Relay-OFF ▼

- Relay-ON
- Relay-OFF
- Relay-CYCLE
- WOL
- SOL

When the number of Ping Failures times have been reached. The device can be set to “ ON , OFF , Reset-Cycle , WOL (Wake on Lan) & SOL (Shut On Lan) “ function

- **Relay ON or Relay OFF:** Turn ON or OFF the outlet
- **Reset -Cycle :** Can set up the time gap from OFF to ON. The “ Sec “ section is for action as Reset only.
- **WOL (Wake on Lan) :** Please refer the page 43 . WOL is for 9823GP-ERL to send WOL command to WIN /LINUX OS to boot up **as that OS is power**

OFF status (not freeze status) The OS mother board need to support WOL function .

- **SOL** (Shutdown on Lan) : Please refer the page 44. SOL is for 9823GP-ERL to send SOL command to the WIN OS which execute our software “ **PowerOFFDelayConfig .exe** ” to shut down up as **that OS is On status** (not freeze status) The OS mother board need to support WOL function .

Relay Outlet #	WOL # or SOL #		DO Outlet #	WOL # or SOL #
1	1		1	5
2	2		2	6
3	3		3	7
4	4		4	8

Wakeup On LAN		MAC	Wakeup	Shutdown On LAN		DelayTime
WOL1	<input type="text" value="000000000000"/>	<input type="button" value="Send"/>	SOL1	<input type="text" value="60"/>	Seconds	
WOL2	<input type="text" value="000000000000"/>	<input type="button" value="Send"/>	SOL2	<input type="text" value="60"/>	Seconds	
WOL3	<input type="text" value="000000000000"/>	<input type="button" value="Send"/>	SOL3	<input type="text" value="60"/>	Seconds	
WOL4	<input type="text" value="000000000000"/>	<input type="button" value="Send"/>	SOL4	<input type="text" value="60"/>	Seconds	
WOL5	<input type="text" value="000000000000"/>	<input type="button" value="Send"/>	SOL5	<input type="text" value="60"/>	Seconds	
WOL6	<input type="text" value="000000000000"/>	<input type="button" value="Send"/>	SOL6	<input type="text" value="60"/>	Seconds	
WOL7	<input type="text" value="000000000000"/>	<input type="button" value="Send"/>	SOL7	<input type="text" value="60"/>	Seconds	
WOL8	<input type="text" value="000000000000"/>	<input type="button" value="Send"/>	SOL8	<input type="text" value="60"/>	Seconds	
<input type="button" value="Apply"/>			<input type="button" value="Apply"/>			

4.3 Network :

The Network Section allows user to setup LAN –Ethernet . There are Static Mode (fixed IP) or DHCP for elect .

Network Setting

LAN IP Select DHCP (Auto Config) ▼

Get LAN IP from DHCP	
IP Address	192.168.100.115
Subnet Mask	255.255.255.0
Default Gateway	192.168.100.1

Secondary IP Enable Disable

Get DNS from DHCP Server	
Primary DNS Server	127.0.0.1
Secondary DNS Server	168.95.1.1

Port Setting	
Port(80~65535)	<input type="text" value="80"/>
WAN IP Address	0.0.0.0
Port Assigned	80

LAN (Ethernet) Settings :

A. STATIC (fixed IP) :

For users who need to control through Internet. Setup IP address manually. This allows the 9823 to obtain an IP Address automatically from user`s server connected to Internet.

Please fill up the IP address , subnet mask and gateway correctly for login from Internet .

B. DHCP Mode :

Recommended for non advance users. This allows the 9823 to obtain an IP information automatically from user`s server connected to Internet. User can only revise PORT which is 80 as default .

As the IP from DHCP Service of user`s router will be changed by router . 9823 will remember last IP of 9823 assigned by user`s router in “Last DHCP state “ for information

Notice :

**Without network connection , the IP address of users Windows PC is 192.168.1.168
So the IP is for user to connect 9823 to PC directly and user do not need to change the
IP of WIN PC connect to 9823 by network cable.**

C. Secondary IP : Enable or disable

This is for advances setting the DNS Server - primary / secondary

4.4 Application Settings

The Application Section allows user to setup email , DDNS , Communication and IP Service .

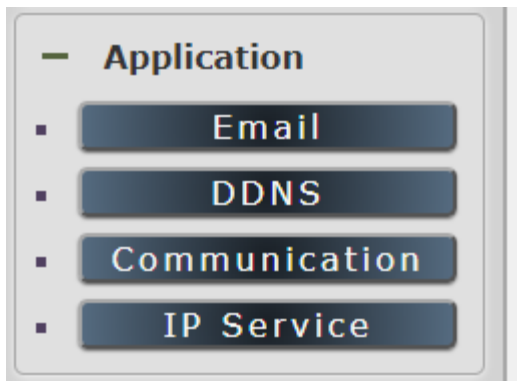

4.4.1 Email

There are 2 sections in this part -- E-mail setting and POP3 Control :

A. Email Setting :

User can get e-mail advice as one of the following situation happen :

- 4 Receive E-mail with IP information & MAC Address as 9823 device boot up.
- 5 Receive E-mail as DI Rising (Low to High) , relay status change in each output .

Notice : To send out the e-mail successfully , please double check the setting of DNS .

(Network → DNS setting)

The 9823 allows user to send from public e-mail account , such as Gmail or Hotmail or other public email address.

- **SMTP Server:** This is the mail server of sender . If user select “ Gmail “ or “ Hotmail “ account as SMTP Server , 9823 will fill the SSL & Port automatically . If user select “Other “ as SMTP Server , please fill the SMTP server information manually .
- **Port :** This is the port of SMTP Server. Most common port to send out e-mail is port 25
- **Start TLS: Enable or disable**
- **User :** Login for the e-mail address . Ex: 9823@gmail.com
- **Password:** Password for the e-mail address. EX : 12345678
- **From :** Mail sender address to send the E-Mail out . Ex: 9823@gmail.com
- **To :** Mail receiver address to get the E-Mail in Ex: 9223@hotmail.com
- **E-mail test :** Can help to check if the e-mail setting works.
- **Apply :** To store the setting in this section .

B. POP3 Control

User can control each port turn ON or turn OFF by e-mail. The command format is limited . Please enable the function first .

POP3 Control <input checked="" type="checkbox"/> Enable	
POP3 Server :	Gmail pop.gmail.com
From :	aviosys@gmail.com
Port :	110
User :	aviosys1
Password :
Tag :	Test
Interval(Minute) :	2
Mail Number :	100
CTRL Format :	<input checked="" type="radio"/> Subject <input type="radio"/> Body

Example:
E-Mail Test:
yourmail
Subject:
IPPOWERCTRL: TAG=Test;POWER1=OFF;POWER2=OFF;POWER3=OFF;POWER4=OFF
Body:

Settings Section :

To set up 9823 be controlled by e-mail , user need to know the both **sender`s e-mail address and receiver`s e-mail account Name and Password.**

- POP3 Server:** This is receiver`s mail server
- From :** Sender`s email address . Ex: aviosys@gmail.com
- Port :** This is the port of POP3 Server.

If user select @gmail or @hotmail account as SMTP Server , 9823 will fill the SSL & Port automatically.
-**User :** Psername to login the receiver`s e-mail Ex: [aviosys1](mailto:aviosys1@gmail.com) or aviosys1@gmail.com

-**Password**: Password for the e-mail address. EX : 12345678

-**Tag** : User can use any message for 9823 to recognize this mail as 9823 command mail .

EX:

As type “ Test “ in TAG area, the command contents is as following:

IPPOWERCTRL:TAG=Test;POWER1=OFF;POWER2=OFF;POWER3=OFF;POWER4=OFF

-**Interval (minutes)** : The period of time between Send and Receive the command e-mail.

-**Mail Number** : For 9823 to search as command mail in the number of user email receiver latest . EX : setup 20 that 9823 will check the latest 20pcs email in receivers mail box for the 9823 command mail

-**CTRL format** : Control format by subject or by body (e-mail contents)

For example : Use Gmail as sender and receiver

Sender's e-mail : 123@gmail.com

The Username to log in sender's gmail : 123@gmail.com or abc@def.com

The Password to log in sender's gmail : 12345678

Command format & Example :

User can get the e-mail command contents in the section . And execute an e-mail as press “Submit “ if user has e-mail setting in the PC as following :

Mail Number : 100

CTRL Format : Subject Body

Apply

Example:

E-Mail Test:
yourmail

Subject:
IPPOWERCTRL:TAG=Test;POWER1=OFF;POWER2=OFF;POWER3=OFF;POWER4=OFF

Body:

Submit

IPPOWERCTRL:TAG=Test;POWER1=OFF;POWER2=OFF;POWER3=OFF;POWER4=OFF - Message (HTML)

Message Insert Options Format Text

新細明體 12

To... aviosys@gmail.com

Cc...

Bcc...

Subject: IPPOWERCTRL:TAG=Test;POWER1=OFF;POWER2=OFF;POWER3=OFF;POWER4=OFF

Command format :

IPPOWERCTRL:TAG=Test;POWER1=OFF;POWER2=OFF;POWER3=OFF;POWER4=OFF

There are 2 sections of the command

1. IPPOWERCTRL:TAG=Test

This is command part. Beside the tag message part (like Test on above example) user can change in setting section , the other command must be **CAPITAL** and are fixed content .

2. ;POWER1=OFF;POWER2=OFF;POWER3=OFF;POWER4=OFF

This is to set the outlet number (POWER1=) and action (ON/OFF) , user can only control 1~4 port ON/OFF by e-mail. Do each outlet command

EX: Put “ 14ON” in tag section and place the command as following : (at subject or body depends one user’s setting) :

IPPOWERCTRL:TAG=14ON;POWER1=OFF;POWER4=ON

E-mail example :

D. Execute e-mail command by “ Subject “

The screenshot shows a web interface with a 'CTRL Format :' label and two radio buttons: 'Subject' (selected) and 'Body'. A red arrow points to the 'Subject' radio button. Below the radio buttons is an 'Apply' button. Underneath, there is an 'Example:' section with 'E-Mail Test:' followed by a text input field containing 'yourmail'. Below that is a 'Subject:' label followed by a text input field containing the command 'IPPOWERCTRL:TAG=Test;POWER1=OFF;POWER2=OFF;POWER3=OFF;POWER4=OFF'. A red arrow points to this 'Subject:' field. Below the 'Subject:' field is a 'Body:' label followed by an empty text input field.

E. Execute e-mail command by “ Body “

The screenshot shows a web interface with a 'CTRL Format :' label and two radio buttons: 'Subject' and 'Body' (selected). A red arrow points to the 'Body' radio button. Below the radio buttons is an 'Apply' button. Underneath, there is an 'Example:' section with 'E-Mail Test:' followed by a text input field containing 'yourmail'. Below that is a 'Subject:' label followed by an empty text input field. Below the 'Subject:' field is a 'Body:' label followed by a text input field containing the command 'IPPOWERCTRL : TAG=Test ; POWER1=OFF ; POWER2=OFF ; POWER3=OFF ; POWER4=OFF'. A red arrow points to this 'Body:' field. At the bottom of the form is a 'Submit' button, with a red arrow pointing to it.

4.4.2 DDNS

The DDNS section allows user to setup the 9823 with a DDNS server (i.e. www.dyndns.com). After the server has been setup correctly, enter the necessary information into the 9823 DDNS settings.

Note : The DNS server will have extra charge as apply new account.



The screenshot shows a web interface titled "DDNS" with a sub-section "DDNS Setting". It contains four input fields: "Service Provider :", "Account :", "Password :", and "Domain Name :". The "Service Provider" dropdown menu is open, showing options: "None", "Dyndns.org", "freedns.afraid.org", "www.zoneedit.com", and "www.no-ip.com". Below the form are "Apply" and "Cancel" buttons.

Account : the Username / account name of DDNS account

Password : the Password of DDNS account

Domain Name : The DDNS name user apply . Ex: abc.dyndns.org

For Example :

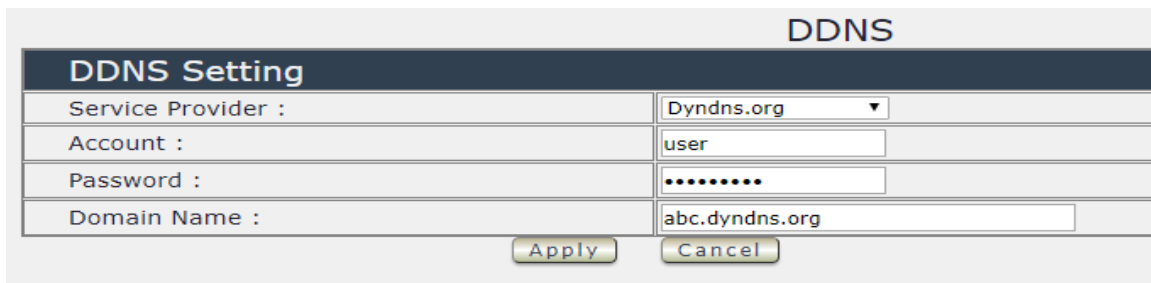

The screenshot shows the same "DDNS Setting" form, but with example values filled in: "Service Provider" is set to "Dyndns.org", "Account" is "user", "Password" is masked with "*****", and "Domain Name" is "abc.dyndns.org". The "Apply" and "Cancel" buttons are visible at the bottom.

4.4.3 Communication

There are 4 different communication : SNMP , Telnet , ModBus TCP & BacNet (Beta)

A. SNMP : Enable or disable

SNMP:	
Enable	<input type="checkbox"/>
Community Authority :	N/A
Community Name :	private
Trap type :	N/A
Host(192.168.1.1:162) :	192.168.1.1:162
Trap Community :	private
MIB file	JPPOWER-MIB.txt
<input type="button" value="Apply"/>	

This section is for development of system integrator who familiar with SNMP knowledge.

B. Telnet : Enable or disable

TELNET:	
Enable	<input checked="" type="checkbox"/>
<input type="button" value="Apply"/>	

C. **Modbus** : We supply 3 models of ModBus control

C-1 ModBUS TCP : Just Enable or disable this function

TCP Modbus	
Modbus Enable	<input checked="" type="checkbox"/>
Server IP	1.34.50.123
Port	502
Baud Rate	38400
SlaveID	1
Parity	None
Modbus ID	1. <input type="text"/> 2. <input type="text"/> 3. <input type="text"/> 4. <input type="text"/> 5. <input type="text"/> 6. <input type="text"/> 7. <input type="text"/> 8. <input type="text"/>
RTU Enable	<input type="checkbox"/>
<input type="button" value="Apply"/>	

C-2 Modbus Gate way model : Need to Enable Modbus , Enable RTU & fill Modbus ID .

C-3 Modbus RTU : Need to Enable Modbus , Enable RTU & fill Modbus ID .

TCP Modbus	
Modbus Enable	<input checked="" type="checkbox"/>
Server IP	1.34.50.123
Port	502
Baud Rate	38400 ▾
SlaveID	1
Parity	None ▾
Modbus ID	1. <input type="text"/> 2. <input type="text"/> 3. <input type="text"/> 4. <input type="text"/> 5. <input type="text"/> 6. <input type="text"/> 7. <input type="text"/> 8. <input type="text"/>
RTU Enable	<input checked="" type="checkbox"/>
<input type="button" value="Apply"/>	

D. BACnet TCP - Beta : Enable or disable

BACnet ^{-Beta}	
Enable	<input type="checkbox"/>
Port	47808
<input type="button" value="Apply"/>	

4.4.4 IP Service

In this section , user can setup

- A. IP Service & CNT (Cross Network Technology) ,
- B. CNT 2 (MQTT)

IP Service & CNT Setting	
Enable	<input type="checkbox"/>
IP Service Server :	Server1 ▼
CNT Server List:	Server1 ▼
Device Name :	Cathy-9823GP-RL
Country :	Country
City :	City
Find Cathy-9823GP-RL device on http://www.myipedit.com	
<input type="button" value="Apply"/>	

CNT2(MQTT)	
Enable	<input type="checkbox"/>
Server :	www.myipedit.com
Port :	1883
User :	ipuser
Password :
<input type="button" value="Apply"/>	

IP Service & CNT Setting :

The IP SERVER allow 9823 to be easily accessed on the internet by our IP Power Center or IP EDIT. With this feature anyone can find there device with no problems.

IP Server: Allows user can find user of 9823 on the internet without having to remember long IP Addresses. Instead user can just remember the name of user device.

- E. Enable IP Server : Enable or Disable this function click .
- F. IP Server & CNT Server : For easily setting , please select same server number for the 2 part.

User can search the 9823 by Device name , Country or City.

This allows the device to easily be accessed on the Internet, user no longer have to Port Forwarding , user device to be able to use it. Only some devices are CNT compatible.

Please refer page #26 for the function of IP Server

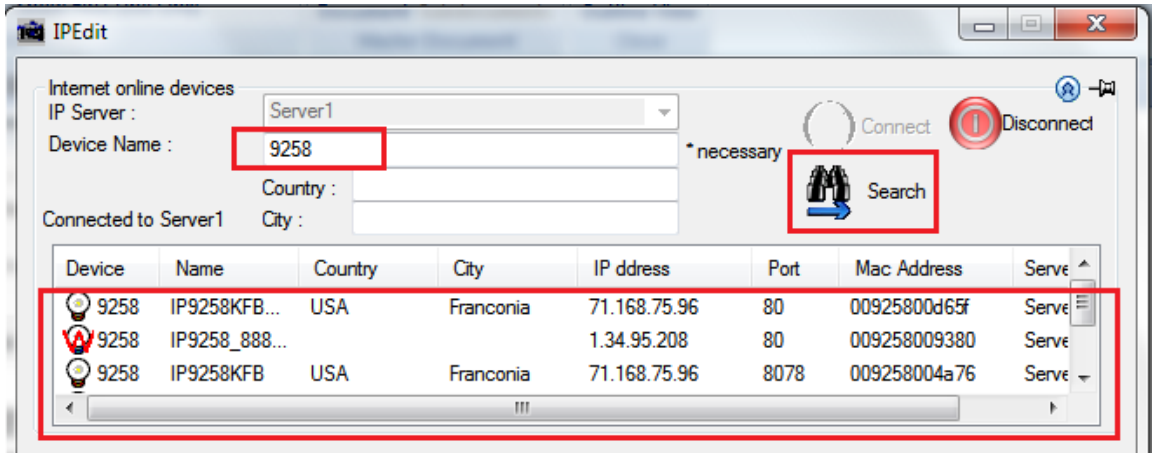

B. CNT2 (MQTT)

Please contact with distributor or us for the details information .

4.5 System Setting

The System Section allows user to do setting of management , system information , Setup SysLog , check firmware version / Update firmware online .

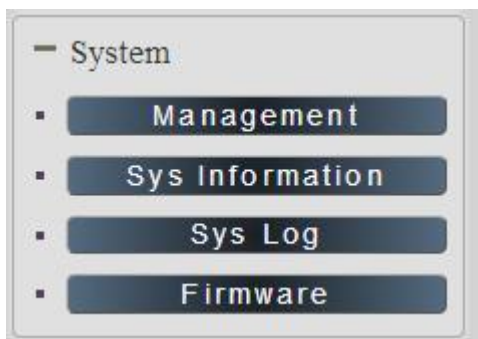

4.5.1 Management

In this section there are several setting :

Administrator setting, Host Connection Interval , NTP setting , Backup Setting , Load Factory Default , Restart System

The message show :

System Management	
You may configure administrator account and password, NTP settings, and Dynamic NTP settings here.	
Adminstrator Settings	
Account	<input type="text" value="admin"/> <input checked="" type="radio"/> Admin <input type="radio"/> Operator <input type="radio"/> Viewer
Password	<input type="password" value="....."/> <input type="button" value="Apply"/>
Language Settings	
Language	<input type="text" value="English"/> <input type="button" value="Apply"/>
NTP Settings	
Date	<input type="text" value="01"/> / <input type="text" value="02"/> / <input type="text" value="2018"/> (MM/DD/YY)
Time	<input type="text" value="11"/> : <input type="text" value="45"/> : <input type="text" value="44"/> (HH:MM:SS) <input type="button" value="Apply"/>
Current Time	<input type="text" value="Tue Jan 2 11:45:43 GMT 2018"/> <input type="button" value="Sync with local time"/>
Time Zone	<input type="text" value="(GMT+0800)ChinaCoast,HongKong"/>
NTP Server	<input type="text" value="pool.ntp.org"/> ex: time.nist.gov
Sync with NTP	Every <input type="text" value="1"/> hours <input type="button" value="Apply"/> <input type="button" value="Cancel"/>
Import configuration files	
Location	<input type="button" value="選擇檔案"/> 未選擇任何檔案 <input type="button" value="Import"/> <input type="button" value="Cancel"/>
System reset	
Export configuration file	<input type="button" value="Apply"/>
Factory Reset	<input type="button" value="Apply"/>
Reboot	<input type="button" value="Apply"/>

Administrator settings

The User Management section allows user to create users that will be able to access user device.

There are two main types of users:

System Management	
You may configure administrator account and password, NTP settings, and Dynamic NTP settings here.	
Adminstrator Settings	
Account	<input type="text" value="admin"/> <input checked="" type="radio"/> Admin <input type="radio"/> Operator <input type="radio"/> Viewer
Password	<input type="password" value="....."/> <input type="button" value="Apply"/>

There are three Authorities in 9823. The account name and password can be changed by user , but each Authorities only support one Account name & one password.

- **Admin:** The *Administrator* has the authority to create other users, remove users, and control the device. 9823 will ask to log in again if change the Default Setting here.
- **Operator :** The operator can only control the setting of “ IO Control “ section but can not see other page of 9823 .
- **Viewer:** The viewer can only see the “ IO Control “ section , but can not see other page of 9823.

Default Setting of the Authorities :

Authority	Account name	Password
Admin	Admin	12345678
Operator	user	user
Viewer	guest	guest
Note	Please amend the password as number or English character from 1 to 8 characters. Do not use special symbol like “ ” ; : ~ ! @ # \$ % ^ & * ()	

Please click “Apply “ button after change the account name / password

Langrage settings

There are three display Language - 3 Language (English , Chinese , Simple Chinese) .

NTP setting

In this section , user can setup the date , time and NTP server to get the time synchronization .

NTP Settings	
Date	01 / 02 / 2018 (MM/DD/YY)
Time	11 : 45 : 44 (HH:MM:SS) <input type="button" value="Apply"/>
Current Time	Tue Jan 2 11:45:43 GMT 2018 <input type="button" value="Sync with local time"/>
Time Zone	[(GMT+0800)ChinaCoast,HongKong ▼]
NTP Server	pool.ntp.org ex: time.nist.gov
Sync with NTP	Every 1 hours <input type="button" value="Apply"/> <input type="button" value="Cancel"/>

NTP synchronization : User can setup the time gap (1~300 hours) for 9823 to check the time with the NET server .

Import configuration files

Back up the setting and setup . User can export the setting of 9823 into a “ DAT “ format .

It will save most the setting in 9823 . User can import the file which is exported from 9823 as “ DAT “ format . It will help user to setup many 9823 device in a short time.

As press “ Import “, there is caution message show as following :

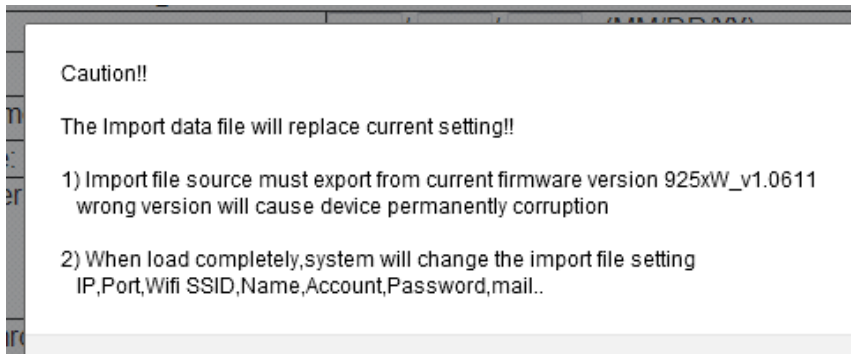

Before click “ Ok “ to import , please do read following notice :

- Do NOT import DAT file which is not export form 9823. The warranty will be invalidated if any wrongdoing from “ Import “ .
- Please do Import the file in LAN / Ethernet . To avoid Import fail , please do not Import file via Internet

System reset

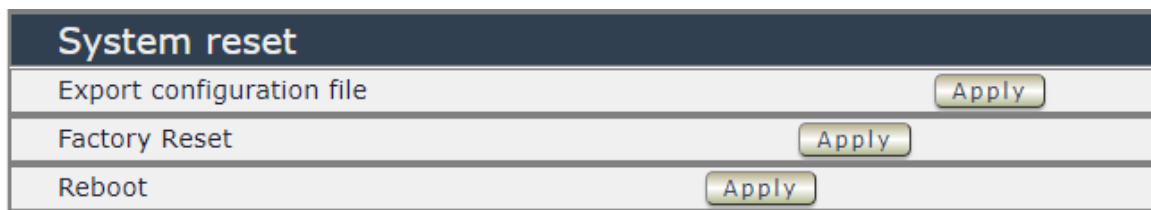

In this section , user can click one button to set back the setting to default or restart the 9823 without device nearby user side.

- **Export configuration** : export the setup into a file for other 9823GP-RL device to import same setting . Like Schedule , Ping , name of power , Relay , DI and DO .
- **Factory Reset** : Set device back to factory default . factory default setting of 9823 IP is assigned by DHCP. It will change the IP if load factory defaults .

Factory Notice :

Caution!!

The system will replace current setting to factory default setting!!

1) if you just updated the newer firmware, please press button at first time.
The Default setting can ensure the newer function match the newer setting.

2) The IP, Port, SSID, Name, Account, Password, mail.. will change to default DHCP Port 80 and password..

- **Reboot** : Power reboot the device directly. It will take around 60 seconds for boot up the 9823GP-RL

4.5.2 System Information

In this section , user can get the system information like System, LAN and others.

System			
System Up Time	13 hours, 12 mins, 23 secs	MAC Address	00:76:23:00:00:24
Firmware Version	v1.00_282_5	Hardware Version	(Dec 21 2017)
WAN			
WAN IP Address	0.0.0.0	Ethernet Port	80
Default Gateway	192.168.100.1	Internet Port	80
Primary DNS	127.0.0.1	Secondary DNS	168.95.1.1
LAN			
Connected Type	DHCP		
Local IP Address	192.168.100.136		
Local Netmask	255.255.255.0		
Other Information			
SNMP	Disable		
ModBusTCP	Disable		
BacnetIP	Disable		
Telnet	Enable		
UPNP	Disable		
IPSERVICE & CNT	Disable		
CNT2	Disable		

4.5.3 System Log

In this section , user can get the 9823 system operation information and send the information to assign Server IP address (not support name) . **The system information will be deleted after 9823 device power reboot.**

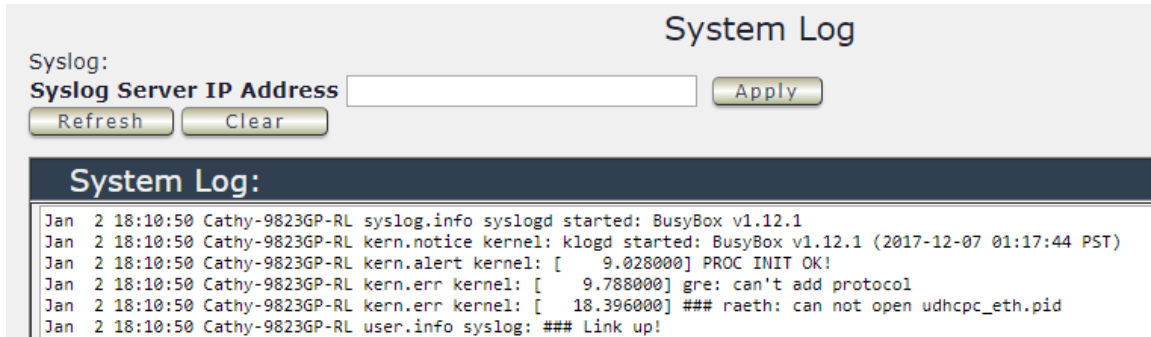

System Log

Syslog:
Syslog Server IP Address

System Log:

```
Jan 2 18:10:50 Cathy-9823GP-RL syslog.info syslogd started: BusyBox v1.12.1
Jan 2 18:10:50 Cathy-9823GP-RL kern.notice kernel: klogd started: BusyBox v1.12.1 (2017-12-07 01:17:44 PST)
Jan 2 18:10:50 Cathy-9823GP-RL kern.alert kernel: [ 9.028000] PROC INIT OK!
Jan 2 18:10:50 Cathy-9823GP-RL kern.err kernel: [ 9.788000] gre: can't add protocol
Jan 2 18:10:50 Cathy-9823GP-RL kern.err kernel: [ 18.396000] ### raeth: can not open udhcpc_eth.pid
Jan 2 18:10:50 Cathy-9823GP-RL user.info syslog: ### Link up!
```

Please click the IP and save by click “ Apply”

4.5.4 Firmware

The firmware update function only support in LAN connection . NOT support under WiFi connection . Before update , please DO **READ THE MESSAGE BLOW** :



Upgrade Firmware

Upgrade selected firmware to obtain new functionality. **Caution! A corrupted image will hang up the system.** It takes about 1 minute to upload & upgrade flash and be patient please.

Firmware	
Location	選擇檔案 未選擇任何檔案

Upgrade selected firmware to obtain new functionality.
Caution! A corrupted image will hang up the system.
It takes about 1 minute to upload & upgrade flash and be patient please.

To update the 9823 , please follow the instruction below to prevent anything happens like **update incomplete** or **hardware disable** which may be caused by wrongdoing of updating . Please also update the notice in webpage before update :

- 1) Turn off all chat programs including (Skype, FB, QQ, AIM, Yahoo messengeretc.)
- 2) Check to make sure that all devices are turned on safely and powered
- 3) While updating do not turn off the power
- 4) Make sure that the cable is connected firmly
- 5) Do not interrupt the update process, the update must be completely finished .
- 6) Turn off, any Spyware or antivirus software which may conflict with the update.
- 7) Update firmware in the Local Area Network (LAN)
- 8) Support update under 32bit Web Browser (32 bit version only) like IE, Google Chrome, Firefox . **Do not use browser at 64 bit version**
- 9) Please change the PORT as 80
- 10) Reboot and Do the Hardware Reset (keep pressing RESET two buttons for 5 seconds and release) after update successfully. There are 4 beep show the reset successfully.**
- 11) **Clear the Cookies** to avoid get the old webpage .

5. Controlling the Device

CGI HTTP Commands

CGI Commands allow user to easily integrate the 9823 with other systems and programs. Please read the instructions carefully on how to use the Http:// Commands

To use http:// Commands open up a web browser and type in the command that user would like to use.

1. User authorization .There are 3 formats :

For example : IP address 192.168.1.18 , Username : admin. Password : 12345678

1.1 <http://admin:12345678@192.168.1.18/set.cmd?cmd=getpower>

1.2 <http://192.168.1.18/set.cmd?user=admin+pass=12345678+cmd=getpower>

The above 2 way also for HTTPS

2. Command

set.cmd?cmd=

All command do not separate capital / lower case , the connect symbol between commands can be “+” , “&” and “?”.

2.1 To get firmware version : getversion

<http://192.168.1.18/set.cmd?cmd=getversion>

System return :

CGI Command : Data follows

Version=9258W_N_v1.0.0.1

2.2 To get MACaddress: getmac

<http://192.168.1.18/set.cmd?cmd=getmac>

System return:

CGI Command : Data follows

mac=00929000008F

2.3 To get the status of power on/ off: getpower

<http://192.168.1.18/set.cmd?cmd=getpower>

System return:

CGI Command : Data follows

p61=0, p62=0, p63=0, p64=0

P61 to P64 means : POWER1 to POWER4

2.4 To set the power on / off : setpower&p6x=0 or 1

p6x=0 means off, p6x=1 means ON, x can be 1 to 4 (power1 to power 4)

Example : Turn on POWER1 and POWER2 and turn off POWER3:

<http://192.168.1.18/set.cmd?cmd=setpower&p61=1&p62=1&p63=0>

System return:

CGI Command : Data follows

p61=1,p62=1,p63=0

2.5 Setup power to reboot as RESET: setpowercycle& p6x=delayTime

X can be 1 to 4 (power 1 to power 4) , ; delayTime mean the time (second) waiting for reset

For example :

<http://192.168.1.18/set.cmd?cmd=setpowercycle> &p61=5&p62=2&p63=4

System return:

CGI Command : Data follows

p61 cycle ok,p62 cycle ok,p63 cycle ok

Telnet Control

```
C:\> Telnet 192.168.1.18

IP login: admin
Password:
```

```
C:\> Telnet 192.168.1.18

#
# ioctrl -h
**-----**
Usage: ioctrl
[-h | --help l.....: display this help
[-s | --setpower p6=0011 or p6x=1(x=1,2,3,4)l.....: turn on/off ports on the d
evice
[-p | --getpower l.: get the on/off status of the device
[-c | --current l.....: get the current value of the device
[-t | --temp l.....: get the temperature value of the device
[-v | --version l.....: display version information
-----
# ioctrl -s p6=1111
p61 ok,p62 ok,p63 ok,p64 ok.
# ioctrl -c
Current value: 0.000000, 0.000000, 0.000000, 0.000000
# ioctrl -t
Temperature value: 32.299999
# ioctrl -v
IO CONTROL Version: 1.0
Compilation Date....: May 14 2013
Compilation Time....: 10:44:47
# ioctrl -p
Power Status: 1, 1, 1, 1
#
```

Notice: The command “-C” & “-T” are for models 9823 only .

6.FAQ :

Q1: Why can't I see the 9823's IP address in IPEDIT.exe ?

Ans.: Please check the PC you use is under same LAN/ network / segment as 9823 .
Please turn off some Anti-Virus / online chatting software .
If there are more than 1 network card , include dynamic network card , please
disable one and make sure the one you selected is
Under the same segment with IP9823.

Q2 : Why can't I see my 9823 after arrange the port forwarding in my router?

Ans. : Please make sure the Network Type (Gateway) is correct - LAN or WAN .

Q3 : Why can't I receive e-mail ?

Ans.: Please check the DNS and GATEWAY setting first (Check user router or ask user ISP company) .There is a test button for checking the setting success or fail to send e-mail.



Notice :

Under DHCP mode - 9823 will get the Network type (Gateway) information automatically. But if under Static mode , please do fill up the correct Network type (gateway) .

Step 3 : Connect user PC and 9823 to a router by LAN. Then **reboot 9823 (MUST DO)** . After 45 seconds with a long beep sound , user can find the LAN IP of 9823 by IPEIDT.exe

Q5: How can I reset to default:

Ans : Keep pressing the button of "RESET for 5 seconds at least

To reset to original manufacture settings : press the reset button with a sharpen pin for 5- 6 seconds then RELEASE. There will be 3 beeps sound which means reset start and 9823 will be rebooted itself -there is one beep after reboot) and most information go back to default setting (LAN IP).