

IP Power 9855 PRO

User Manual



Version: 1.05
Firmware Version: V1.16
Date Released: July. 2024

Warning: Any changes made to this equipment without permission may cause damages to the device!

IMPORTANT NOTICE

1. IP Power 9855 PRO was designed for indoor use, we carry no responsibility for possible damages caused by outdoor use, especially in the rain.
2. Please use the power adapter provided by the dealer, we carry no responsibility for the possible damage from using power adapters not provided by us.
3. Do not shake the IP Power 9855 PRO in any fashion.
4. Please contact the dealer If IP Power 9855 PRO is not working properly.

Copyright © 2024 All rights reserved. No part of this publication may be reproduced, stored in a retrieval system, or transmitted in any form or by any means, electronic, mechanical, photocopying, recording or otherwise, without the prior written consent of us.
All trademarks and products mentioned in this document are the properties of us.

Table of Content

| | |
|--|-----------|
| 1.Introduction | 5 |
| 2.Product Information..... | 6 |
| 2.1 Features | 6 |
| 2.2 Minimum System Requirements | 7 |
| 2.3 Package Contents..... | 7 |
| 2.4 Interface Description | 8 |
| 3.Setting up your device..... | 9 |
| 3.1 Before Starting..... | 9 |
| 3.2 Change settings | 9 |
| 3.3 Hardware Connection | 11 |
| 3.4 Software Installation | 12 |
| 3.3.1 LAN connect by IP search software “ IPEDIT ” | 12 |
| 3.3.2 Internet Setup | 14 |
| 3.3.3 Using IP Service | 15 |
| 3.3.4 mDNS connection..... | 16 |
| 4. Web Interface..... | 17 |
| 4.1 Connect to your device | 17 |
| 4.2 Top Column | 18 |
| 4.2.1 Device name | 18 |
| 4.2.2 Date and Time..... | 19 |
| 4.2.3 Current Usage & Temperature | 20 |
| 4.3 Power Control | 21 |
| 4.3.1 Control | 21 |
| 4.3.2 Schedule..... | 24 |
| 4.3.3 Ping..... | 26 |
| 4.3.4 QR code | 30 |
| 4.4 Network | 33 |
| 4.4.1 Interfaces | 33 |
| 4.4.2 802.1X Client..... | 36 |
| 4.4.3 Web Port | 37 |

| | |
|---------------------------------------|-----------|
| 4.5 System..... | 39 |
| 4.5.1 Management | 39 |
| 4.5.2 Information | 43 |
| 4.5.3 Email..... | 44 |
| 4.5.4 System Log | 45 |
| 4.5.5 Backup / Flash firmware..... | 47 |
| 4.5.6 Reboot..... | 48 |
| 4.6 Application | 49 |
| 4.6.1 IP Service | 49 |
| 4.6.2 SNMP | 51 |
| 4.6.3 Network UPS Tools | 53 |
| 4.6.4 Watchcat | 56 |
| 4.6.5 Wake on Lan..... | 61 |
| 5. Other ways to control | 62 |
| 5.1 CGI HTTP Commands | 62 |
| 5.2 SSH commands | 64 |
| 6. FAQ : | 65 |

1.Introduction

IP Power 9855 PRO is a new generation of the Power Distribution Unit (PDU) & Remote PowerControl (RPC) system which add "Active Spike Filter Design" in the hardware design and make the system with higher grade stability.

With embedded web server and **HTTPS** protection, 9855 PRO supports higher grade security as working on Internet. User can control power easily and more safely through the web browser in Windows, Android or iOS system, like Internet Explorer (IE) / **Edge**, Google Chrome, Safari web browser.

As support **SSL & SNMP**, user can use public email like Gmail / Hotmail / Yahoo Mail to get the email as the ON/OFF status changed.

9855 PRO supports **Auto Ping, Time Scheduler** which is more suitable for factory / commercial / office / home automation. User can get the device status in LOG information or in remote IP address which sent to get LOG message from 9855 PRO (SYSLOG).

For system integrator, there are several popular developing tolls like HTTP/CGI command, SSH, **SNMP**

User Friendly. Convenience & Powerful,



2.Product Information

2.1 Features

1. Single port Remote power controller for power On, Off and Reboot by the internal power switching use 40A relay.
2. Add " Active Spike Filter Design" for higher stabilities.
3. Current meter up to 10 Amp
4. Web Server built-in design, directly control by web browser in Windows, **Android** or **iOS** system like Internet Explore (IE), Google Chrome and so on.
5. Support **HTTPS**, SSL , TCP/ IP , DHCP, DDNS , SMTP , **SSH** ,and **SNMP**
6. **SYSLOG** : Support Log function & send to assign IP address
7. Time Schedule - can pre-set a suitable time to turn power on / off automatically.
8. **Auto Ping** for network control & segment management automatically
9. High grade components for long stability and performance
10. **Back Up** for quick setup for multiple devices.
11. Support public e-mail -- @gmail.com , @yahoo.com , @hotmail. com.....etc.

12. Specific software developed by Aviosys and provided free of charge :
 - SDK Available : HTTP Command
 - Windows software " IP Power Center " : Control Multiple Aviosys IP Power devices in one software
 - CNT software (Cross Network Technology)- allows user eliminate set up work on any Router without port forwarding , simply Plug & Play .

13. Support different models with different power plug, ex: USA, UK, GE, FR, AU etc.....

14. **USB Port** - to get the information of external UPS device .

Specification

- Power input: 100A~240VAC C14 in, 10A
- Maximum of Total loading: **15 A**
- Dimensions: 86 x 86 x 80 mm (L x W x H)
- Weight: 314.6 g
- Enclosure – Plastic case in white color
- Operating **Temperature**: 0~50 °C
- Note: The internal power switching relay support up to 40A and support inrush current up to 350A immunity.
Phase shift switching circuit prevent contact EMI and spike.

2.2 Minimum System Requirements

- Network & Web Browser & Internet Connection
- Ethernet Cable & Power Cord

2.3 Package Contents

- 9855 PRO Unit
- Online CD note : www.aviosys.com/cd

2.4 Interface Description

Outlook



Front :

| | |
|---------------------|---|
| Ethernet | LAN 10/100 Mbps network for Internet |
| USB port | Connect for UPS to get power information. |
| LED (status) | Display the outlets as ON (Green) or OFF (RED) |
| Reset | Please keep pressing the button for 7 seconds and then release. You will hear 3 short beep sound which show the reset Successfully. After reset, all the settings, like IP, password and so on , will be back to Default. |

Back:

| | |
|----------------|-------------------------|
| Input : | 100A~240VAC C14 in, 10A |
|----------------|-------------------------|

Top:

| | |
|---------------|--|
| Output | The Power output is on the top of the device. Simply plug in the device that you world like to control power. (Comes in different plug standards) |
|---------------|--|

3. Setting up your device

3.1 Before Starting

*Before setting up the device make sure of the following:

- 1.) All the package contents are all included if anything is missing please contact the dealer where the device was purchased from.
- 2.) Check the power input cable is working correctly.
- 3.) Check all cables to make sure there are no problems with it.



3.2 Change settings

Before you change the settings in 9855 PRO, please read this how the saving settings works in 9855 PRO.

For example:

In the network-interface webpage, we can see this image that settings didn't change before adjustment. In the right-down corner, you can see three icon: Save & apply, Save and Reset.

interface

| | | |
|--|---|----------------------|
| lan  br-lan | Protocol: DHCP client Uptime: 1d 20h 52m 43s MAC: 00:76:56:00:43:21 RX: 147.97 MB (943404 Pkts.) TX: 13.67 MB (83652 Pkts.) IPv4: 10.33.122.43/24 | Edit |
| lan6  br-lan | Protocol: DHCPv6 client Uptime: 1d 20h 54m 5s MAC: 00:76:56:00:43:21 RX: 147.97 MB (943404 Pkts.) TX: 13.67 MB (83652 Pkts.) IPv6: 2001:b011:3801:3388:276:56ff:fe00:4321/64 | Edit |

[Save & Apply](#) [Save](#) [Reset](#)

Save & Apply: Save and apply your device settings.

Save: Save only, the device will remain your adjustment, but won't apply the settings.

Reset: Recover the settings before you click "save & apply" or "save" new changes.

If you want to change the setting once and for all, then click Save & Apply, the changes setting will apply immediately. But if you want to save the setting but don't want apply immediately, click the save bottom.

Save:

If you want to change the settings, only click the save bottom, it will happen like this. Not only the setting section changed but also can see the unsaved change in the right top. This means you didn't finish your setting, and the system help you save the setting if you want to apply it.

ER 2023/06/21 06:01:50 Refreshing **Unsaved Changes: 4**

interface

| | | |
|------------------------------|---|------|
| lan Alias of "lan" | Protocol: Alias Interface (DHCPv6 client) Interface has 4 pending changes | Edit |
| lan6 br-lan | Protocol: DHCPv6 client Uptime: 1d 21h 1m 15s MAC: 00:76:56:00:43:21 RX: 148.50 MB (947101 Pkts.) TX: 14.17 MB (84927 Pkts.) IPv6: 2001:b011:3801:3388:276:56ff:fe00:4321/64 | Edit |

Save & Apply Save Reset

Click the Unsaved changes you will see the small screen shows " Configuration / Changes ". It show the section you have added, changed or removed, the changes based on different colors to show how many section you want apply.

If you don't want " Save & Apply " the settings, click the " revert ", the settings will turn back to the original settings before saving.

IP_POWER 2023/06/21 06:01:09 Refreshing **Unsaved Changes: 4**

Power Control interface

Network Interfaces

lan Protocol: Alias Interface (DHCPv6 client)

Configuration / Changes

Legend:

- Section added
- Section removed
- Option changed
- Option removed

```
# /etc/config/network
uci set network.lan.proto='dhcpv6'
uci set network.lan.device='@lan'
uci set network.lan.reqaddress='force'
uci set network.lan.reqprefix='auto'
```

Close Save & Apply Revert

3.3 Hardware Connection

Before hardware connection, please make sure that there is no more than 2 network cards(include dynamic network card). If there are more than two network card in your PC. You may not get the IP address of 9855 PRO

Please connect the 9855 PRO under your router or to the PC directly.

The default IP of 9855 PRO is 192.168.1.168 .

To log in to the 9855 PRO directly, please make sure the IP address of you PC is also the same segment as the 9855 PRO, like 192.168.1.XXX (XXX = 1~254) or you may not log in the 9855 PRO webpage as different segment .

User can change the FIX IP mode to DHCP mode through our IP search tool “ IPEDIT “ or through the 9855 PRO webpage as log in. As change to DHCP mode, 9855PRO will get the IP address from user`s router.

The way to use IPEDIT to change 9855 PRO as DHCP is as following :

Step 1 : Select the 9855 PRO IP show in the IPEDIT. It shows FIX IP below MAC address section.

Step 2: Select DHCP area and click “ Submit “ then it will ask to type the username and password.
Please fill root & 12345678 and click OK / setup.

Step 3: Wait for one minute for 9855 PRO reboots up and click the rescan button in IPEDIT to get the new IP address which is assigned from your DHCP router. Then you can also find the 9855 PRO show DHCP in IPEDIT tool.

3.4 Software Installation

Please go to our webpage www.aviosys.com/cd to get the software and manual of your product.

Under windows system, we offer two software:

1. IP Edit (Require to search IP address)
2. IP Power Center (For multiple IP Power devices control purpose)



- 1.) Select the IP Power 9855 PRO
- 2.) All the available downloads for the 9855 PRO will be shown
- 3) Download the required software – **IPedit.exe** - by clicking on the download button.



Then you can select to connect 9855 PRO.

3.3.1 LAN connect by IP search software “ **IPEDIT** ”



IP Edit is a search tool designed to search, configure, or access the IP Power 9855 PRO from a localnetwork computer.

IP Power 9855 PRO Default Login / Password

Default IP: 192.168.1.168
Default Login username : root
Default Password: 12345678

Please use our IP Search tool “ IPEDIT.exe ” to get the IP address of 9855 PRO .

1.) In the local devices section user will see user device shows up if connection is correct.

For example:

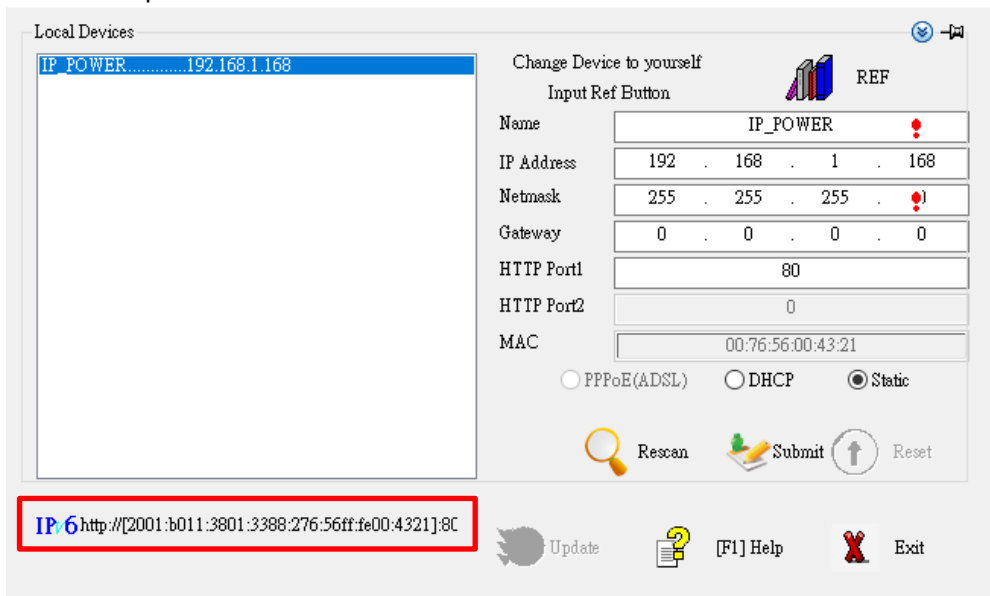

The default IP of 9855 PRO is 192.168.1.168.

- **Red rectangle** show the **IPv6** address of IP9855 PRO, only IP9855 series can display the **IPv6** address.

To log in to the 9855 PRO directly, please make sure the IP address of you PC is also the same segment as the 9855 PRO, like 192.168.1.XXX (XXX = 1~254) or you may not log in the 9855 PRO webpage as different segment .

User can change the FIX IP mode to DHCP mode through our IP search tool “ IPEDIT ” or through the 9855 PRO webpage as log in . As change to DHCP mode, 9855PRO will get the IP address from user`s router.

The way to use IPEDIT to change 9855 PRO as DHCP is as following :

- Step 1 : Select the 9855 PRO IP show in the IPEDIT. make sure your device is connect the one you want to modify, check the Mac address. You can check the Mac in the bottom of device.
- Step 2: Select DHCP icon and click “ Submit “ then it will ask to type the username and password.
Please fill root & 12345678 and click OK / setup.
- Step 3: Wait for one minutes for 9855PRO reboot up and click the rescan button in IPEDIT to get the new IP address which is assigned from your DHCP router . Then you can also find the 9855PRO show DHCP in IPEDIT tool.

Notice:

If can't see the IP in the area of Local Devices of IPEDIT.exe. Please check the following situation

1. **Boot up successfully:** Please reboot the 9855 PRO and check if there are 1 short beep after 1 minutes. This beep means the device boot up successfully. If not, the device may have issue.
2. **Network card:** Please check if there are more that two network card – include wire / wireless / dynamic - in the PC which used IPEDIT software . IPEDIT only support single network PC, please disable the other network connection / functions.
3. **Anti Virus software / Firewall:** Please turn off the antivirus software firewall temporary.
4. **Connection:** Please make sure that the 9855 PRO is under same router with the PC used IPEDIT . It is fine to connect across multiple routers but it need to setup the MASK part which need some knowhow.

Notice :

Segment : The first 9 digits of the IP Address .

EX: The IP of user PC is 192.168.100.122. If the “ Local IP Address “ at Wi-Fi Info is 192.168.100.x (X can the value of 1~254) , user PC can get into the webpage of 9855 PRO .

3.3.2 Internet Setup

To connect the IP Power 9855 PRO on Internet, there are two ways

- Setup Port Mapping / Port Forwarding in your router. Please check your Router owner's manual .
- Use our own software “ IP Power Center “ : Please refer to the “IP Power Center “ manual in software section of www.aviosys.com/cd

3.3.3 Using IP Service

IP Service is a function which allows user to search for the device easily without having to remember long complicated IP address. Instead, if user know the device's name of user's IPPower device and user can easily find IP Address with IP Service. **To log in the webpage of 9855 PRO on Internet, user still need to do the "Port Forwarding" in own router.**

Before using "IP Service ", please change the device name of user 9855 PRO to avoid similaname in Host Server.



1.) Open IP Edit and select the server that user's 9855 PRO is designated to.

2.) Hit the Green Connect button on the top of IP Edit.

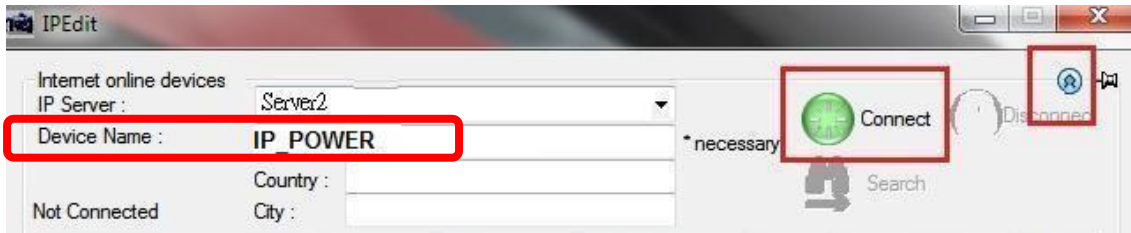

3.) Then type in the 9855 PRO Name that user have selected for the device and press the Searchbutton.

4.) Find user device and double click on the screen and a IE window will pop up connecting to user device. *User device must be Port Forwarded for the login screen to appear.

EX: The 9855 PRO device name as IP_POWER, and user can search the device easily :

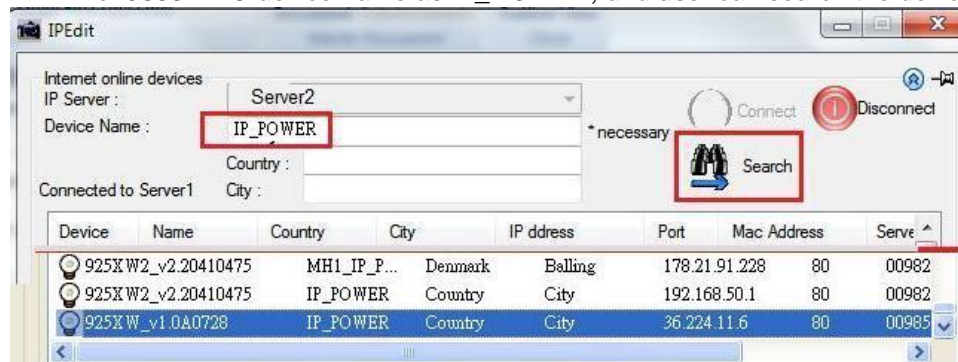

5.) After user has connected to user device, type in the Login and Password for user device

3.3.4 mDNS connection

You can log in to your IP9855 PRO without using its IP address. With mDNS support, you only need to type: “ ip_power.local ” to access the 9855 PRO web UI.

If you have multiple IP9855 W devices connected to the same PC, you can't use “ ip_power.local.” Please locate your MAC address, which is on the side of your device. Use the last two digits of the IP9855 PRO MAC address to connect.

Please follow the instructions below:

Only one IP9855 PRO connected to the PC

- (1) Open any web browser (recommand Chrome, Edge).
- (2) In the address bar, type “ ip_power.local ” and press Enter.

2. Multiple IP9855 PRO or others 9855 devices connect in the same PC.

- (1) Find your device's MAC address, which is located on the side of your device.

MAC example: 007655000520

- (2) Open any web browser (recommand Chrome, Edge)
- (2) In the address bar, type “ ip_power_XX.local ”, where XX is the last two digits of your 9855 W MAC address.

Example: If the MAC address is 007655000520, type “ ip_power_20.local. ”

After typing the address in your browser's address bar, press enter. You will see the login screen. Indicating that you have successfully connected to your IP9855 W.

4. Web Interface

4.1 Connect to your device

Once the 9855 PRO has been setup correctly, log into the device.

First Option

- 1.) Go to IP Edit to find the device that is being used
- 2.) Double click on the device linked and an IE window will appear with the loading screen

Second Option

- 1.) Open Internet Explorer type in the IP Address of the device followed by the sign.
For example: http:192.168.122.188:9258
192.168.122.188 – IP Address
- 2.) Once you have typed in the IP address of the 9855 PRO and it is ready to be worked.

The default Username and Password for the 9855 PRO

Username : root

Password : 12345678

The Control Console

The right side Menu of the Web Interface for controlling the functionality and setup of the IPPower 9855 PRO.

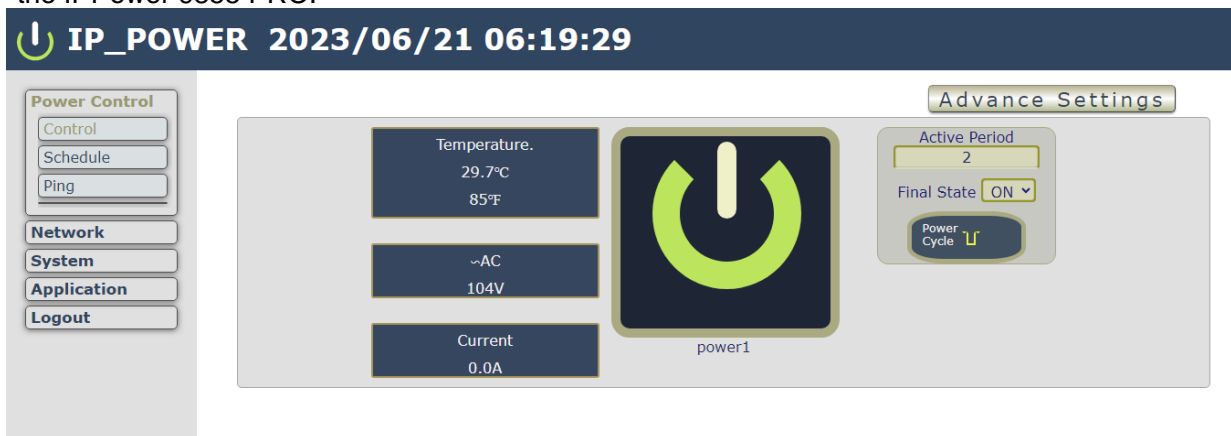

The IP Power 9855 PRO Console consists of six main sections which will be explained in details below.

- **Top Column** : Temperature, Current Amp Usage, ~AC usage & Device name, Time information
- **Power Control** : Control, Schedule, Ping
- **Network** : Interfaces, Webport
- **System** : Management, Information, E-mail, System Log, Backup / Flash firmware, Reboot,
- **Application** : IPService, SNMP, Network UPS tools, Watchcat, Wake on Lan
- **Logout**

4.2 Top Column

4.2.1 Device name

This section show the device name. You can change the device name here: Application → IP Service → Device name Change name “ IP POWER 9855 PRO “ as “Enjoy 9855 PRO “

Power Control
Network
System
Application
IPService
SNMP
Network UPS
Tools
Watchcat
Wake on LAN
Logout

IP Service Setting (Search)

Enable

IP Service Server Server1

Device Name: IP_POWER

Country Country

City City

Find IP_POWER device on myipedit.com

Save

CNT(MQTT) Setting (Remote control)

MQTT Service IPPower

Enable

Status

Save

Notice : Please do not use symbol like !@#\$%^&*()_+ as the character of the device name .

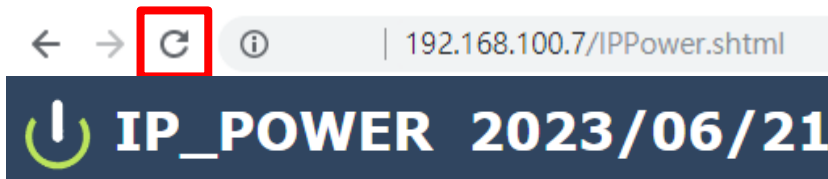

After apply the change, please click “ Refresh “ of the webpage to get the display update .

4.2.2 Date and Time

In this section, it shows Time at **Year – Month – Date, Hours : Minutes : Seconds** .



To setup the Time, Please go to “ System → Management → System (Time & Language) → General Settings ”,

In Sync section, user can select the time to sync with local PC browser or with assigned NTP server, please press “ Save & Apply ” to save the new setting.

[System](#) [Password](#) [SSH Access](#) [SSH-Keys](#) [HTTP\(S\) Access](#) [ACL Settings](#)

Time & Language

Here you can configure the basic aspects of your device like its Language or the timezone.

[General Settings](#) [Time Synchronization](#) [Language](#)

| | | | |
|------------|---------------------|-----------------------------------|--------------------------------------|
| Local Time | 2023-06-19 10:59:08 | Sync with browser | Sync with NTP-Server |
| | 2023-06-19 10:59:01 | Set time manual | |
| Timezone | Asia/Taipei | | |

[Save & Apply](#) [Save](#) [Reset](#)

1. SYNC:

- (1) With browser: Sync with the browser log into 9855 PRO.
- (2) With NTP Server: - sync with the assigned sever and can setup the times for sync. Move to the “ Time Synchronization ”, and click the enable NTP client.

2.Timezone: You can choose UTC or other country/region timezone.

To use the time to sync with NTP server, please setup the NTP server in Time Synchronization

[System](#) [Password](#) [SSH Access](#) [SSH-Keys](#) [HTTP\(S\) Access](#) [ACL Settings](#)

Time & Language

Here you can configure the basic aspects of your device like its Language or the timezone.

[General Settings](#) [Time Synchronization](#) [Language](#)

| | | | | | | | | | | | |
|-----------------------------|---|------------------------|---|------------------------|---|------------------------|---|------------------------|---|--|---|
| Enable NTP client | <input checked="" type="checkbox"/> | | | | | | | | | | |
| Use DHCP advertised servers | <input checked="" type="checkbox"/> | | | | | | | | | | |
| NTP server candidates | <table><tr><td>0.openwrt.pool.ntp.org</td><td>-</td></tr><tr><td>1.openwrt.pool.ntp.org</td><td>-</td></tr><tr><td>2.openwrt.pool.ntp.org</td><td>-</td></tr><tr><td>3.openwrt.pool.ntp.org</td><td>-</td></tr><tr><td></td><td>+</td></tr></table> | 0.openwrt.pool.ntp.org | - | 1.openwrt.pool.ntp.org | - | 2.openwrt.pool.ntp.org | - | 3.openwrt.pool.ntp.org | - | | + |
| 0.openwrt.pool.ntp.org | - | | | | | | | | | | |
| 1.openwrt.pool.ntp.org | - | | | | | | | | | | |
| 2.openwrt.pool.ntp.org | - | | | | | | | | | | |
| 3.openwrt.pool.ntp.org | - | | | | | | | | | | |
| | + | | | | | | | | | | |

[Save & Apply](#) [Save](#) [Reset](#)

Notice: As using NTP server, as webpage time count will be slower than the device time, please refresh the webpage or use the SSH command to confirm the device time.

```
login as: root
root@10.33.122.2's password:

BusyBox v1.35.0 (2023-03-22 03:02:41 UTC) built-in shell (ash)

_ _ _ _ _
| | | | | | | | | | | | | | | | | | | | | |
|_|_|_|_|_|_|_|_|_|_|_|_|_|_|_|_|_|_|_|_|_|
-----
Enter 'ioctl -h' for a list of built-in commands.
-----
root@IP_POWER:~# date
Fri Jun 30 07:39:28 UTC 2023
root@IP_POWER:~# █
```

4.2.3 Current Usage & Temperature

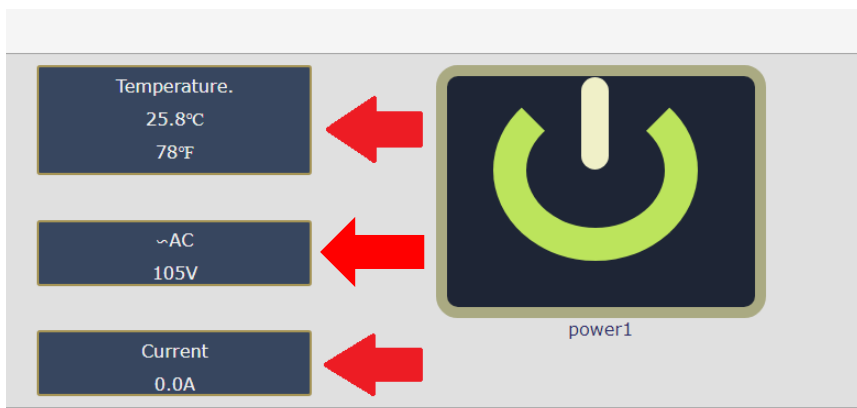

- Temperature: the sensor is in 9855 PRO box. Range 0~50 °C or 32-122 (°F)
- ~AC: Detection of the AC usage.
- Current : It show the total current usage of outlet. The maximum current detection is up to 10A

4.3 Power Control

The IO Control Section allows you to directly / automatically control the outlets of the 9855 PRO as well as schedule Once, Daily, Weekly, and power cycles.

There are 4 sections: Control, Schedule, Ping and QR code



4.3.1 Control

There are 2 setting pages in this Section. One is "Power Control" and another one is "Advance Setup"

A. Power Control :

User can do the following 3 basic operation in this page :

1. Manual control: each port ON or OFF directly by pressing the power sign.
2. Power Cycle control : Manually Control the relay delay to turn ON / OFF. The relay cycle time can be set from 1 to 9999 seconds

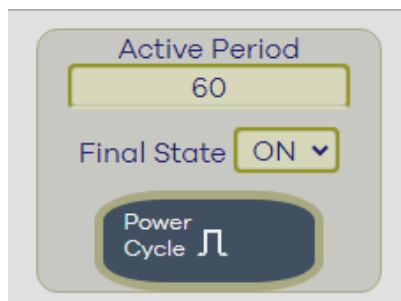

User can set up the time and the final status in power cycle as ON / OFF.

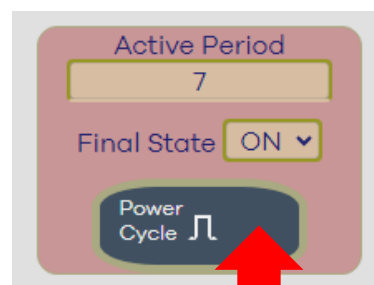
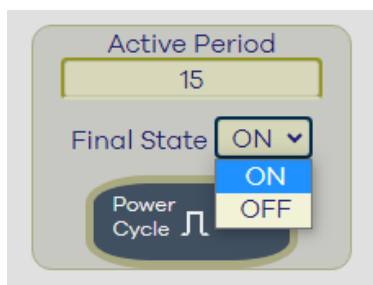

For example : (sec = seconds)

- Original Outlet as “ OFF “ , select final status as “ ON “ & fill 15sec :
After press power cycle button, the outlet will turn OFF for 15 seconds and then turn ON .

OFF (15 sec) → ON

- Original Outlet as “ ON “ , select final status as “ ON “ & fill 10sec :
After press power cycle button, the outlet will turn OFF for 10 seconds and then turn ON .

ON --> OFF (10 sec) → ON

- Original Outlet as “ OFF ” , select final status as “ OFF “ & fill 8 sec :After
press power cycle button, the outlet will turn ON for 8 seconds and then
turn OFF .

OFF → ON (8 sec) → OFF

- Original Outlet as “ ON “ , select final status as “ OFF “ & fill 5 sec :

After press power cycle button, the outlet will be ON for 5 seconds and then turn OFF .

ON (5 sec) →OFF

The following 3 pictures shows that after press the power cycle with 5 seconds setting, the outlet “ Power1 “ will turn off for 5 seconds , then turn ON later . The power cycle action will execute after press the “ Power Cycle ” button.

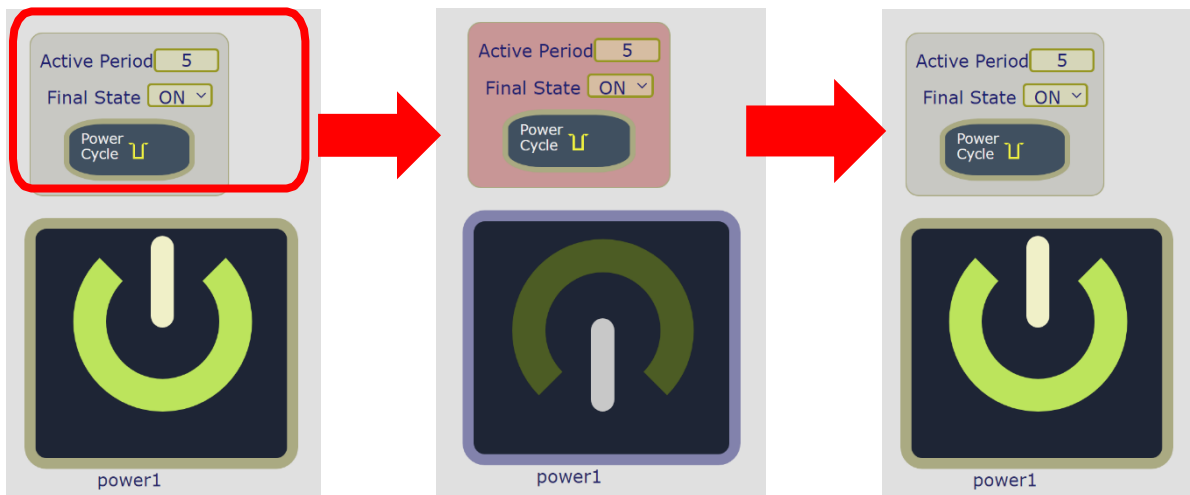

B. Advance Setup :

User can do the following 8 advance operation in this page :

➤ Port Name setting:

User can name each power by click the name above the power button

The number of character is max. 12 characters and Please change the name in English only and do not use symbol like !@#%&^*()_+

Control

| | |
|---|--------------------------|
| Outlet1 | power1 |
| Disable Control Button | <input type="checkbox"/> |
| Disable Power cycle Button | <input type="checkbox"/> |
| Email Alerts | <input type="checkbox"/> |
| Beep Alert | <input type="checkbox"/> |
| Power Cycle Time | 60 Seconds |
| Current (1-10)Amp | 8 |
| Temperature Limit:0-60°C Low: 0.(High: 60 | None |
| Default Power Status | LAST |

Save

Temperature: 29.6°C
85°F

~AC: 103V

Current: 0.0A

power1

Active Period: 60
Final State: ON

Power Cycle

- **Disable Control Button :**
Stop to control ON/OFF in the webpage manually.
9855 PRO will follow control by HTTP/CGI command or by Schedule setting.
- **Disable Power cycle Button :**
Stop to “power cycle“ control in the webpage manually . 9855 PRO will follow control by HTTP/CGI command or by Schedule setting.
- **E-mail Alarm Setting :**

User can enable /disable the e-mail alarm here. Please refer the page 33 to setup the email information in “Application “ → Email .

The e-mail alarm section allows 9855 PRO to notify user by following situation :

- Receive E-mail with IP information & MAC Address as 9855 PRO device boot up.
- Receive E-mail as ON/OFF status change in output.

- **Beep Alert :** User can setup the operation beep (short time beep) sound here.
- **Default Power Status:** The control section allow user to set the power status on ON or OFF or LAST when the device power Rebooted. The output will be same status as choose LAST before the device power turn off. To save the setting here, please click “Apply “ button .

Note : Please change the name in English only and do not use symbol like !@#%&^*()_+

4.3.2 Schedule

In this section, user can see the setting schedule list first up to 30 rules. To setup each schedule, please press “ Schedule Setting “ , then user can get the “ Schedule List “ page as following :

Please click the button to switch between “ Schedule Setting “ & “ Schedule list “ :

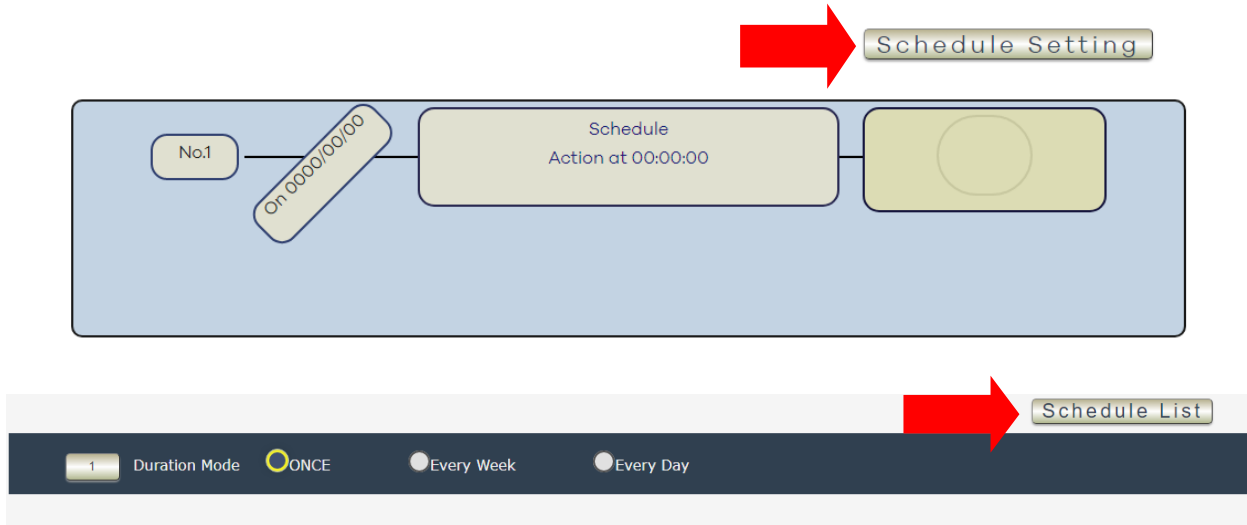

The schedule allows you to control the power outlet turn ON, OFF, Cycle or Reboot at the assigned time user arrange in schedule

- Adding a Scheduled Event

1. Select the Action Duration :

There are 3 setting – Once, Every Week, Every Day

2. Select a Specific Date Range where the device will repeat the desired actions during the time specified.



3. Select the Time Period.

4. Choose the Action : Enable power # by clicking in the small square to mark “ v “ , and select one from the power action of OFF/ON/cycle/reboot as you need.

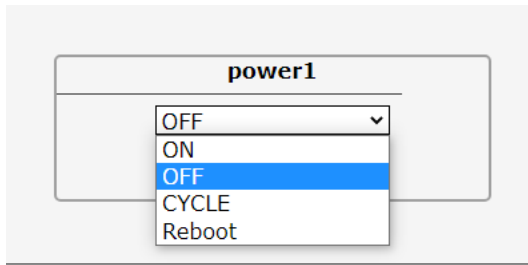

Once the scheduler has been Set Up, click the “ Save ” button and you will see your setting located on the bottom of the Action section.

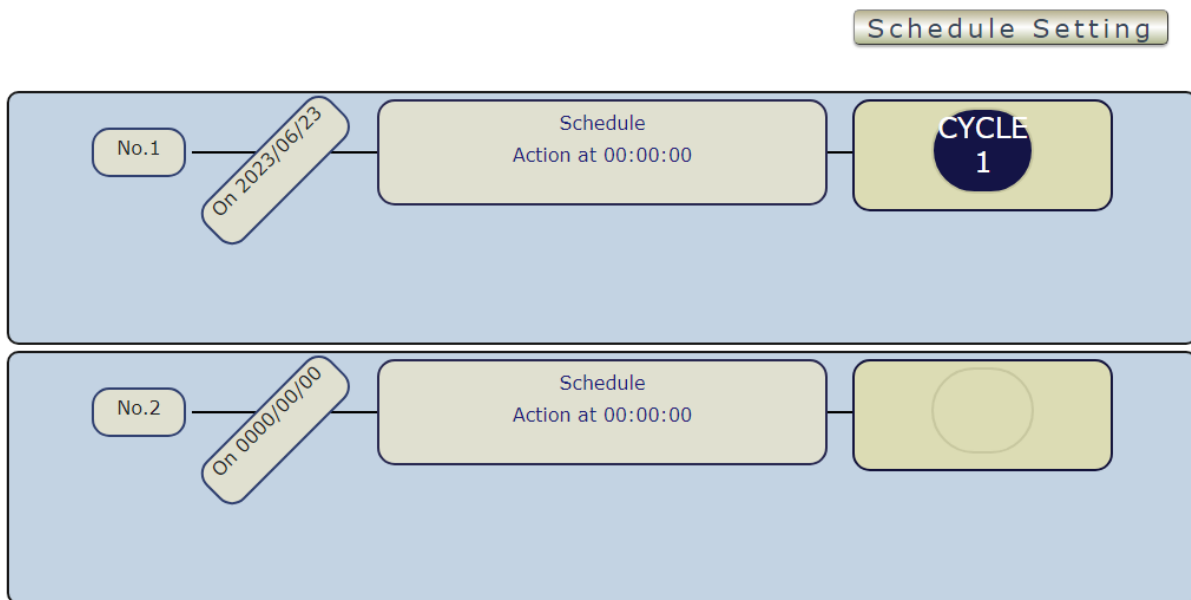

- **Apply / Edit a Schedule Event :**



Please select the Rule you want to edit in Scheduler Table. Change the setting like Duration , Date , Time and Action. Then Press “ Save ” button to confirm the setting and you will see the page refresh and new setting display in Scheduler list

- **Delete -** Click “ Delete “ button to remove a rule from the list .

4.3.3 Ping

The Ping function allows the device to Ping an IP Address automatically to act as a watchdog to make sure the device getting Ping and working properly. Please Click the button to switch between “ Ping Setting “ & “ Ping List ”. User can hide the setting section by press “ Ping List ”.

There are 1 rules for Ping .

- **Ping List Page :**

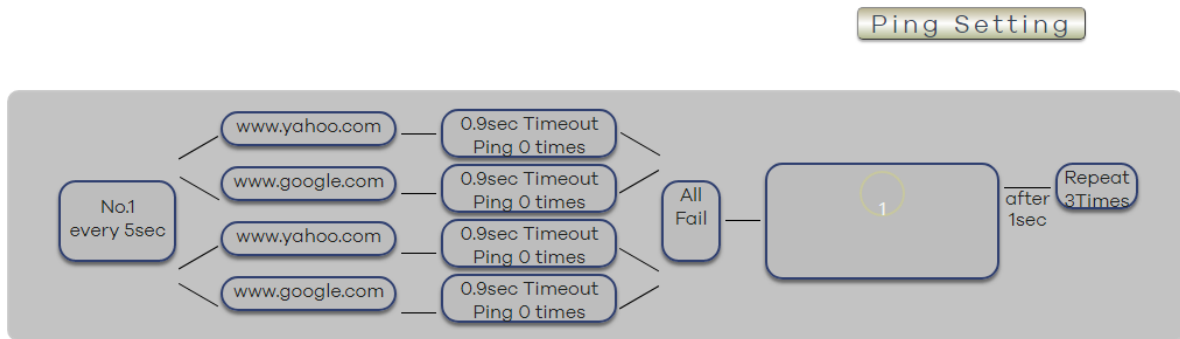

- **Ping Setting Page :**

Ping List

Global Ping Base Setting

| | | | |
|-------------------------|-----------|--------------------------|-------------------|
| Ping Interval: | 5 Sec. | Response Time Out: | 900 ms. |
| Ping After Action Delay | 1 Sec. | Action Max repeat Times: | 3 (0=non stop) |

Apply

Logic Mode: Single OR And

| IP & Host Name | Failed times | Repeat |
|-----------------------------|--------------|--------|
| www.yahoo.com Check | 00 | Stop |
| www.google.com Check | | |
| www.yahoo.com Check | | |
| www.google.com Check | | |

Action

Save **Delete**

Rule No1

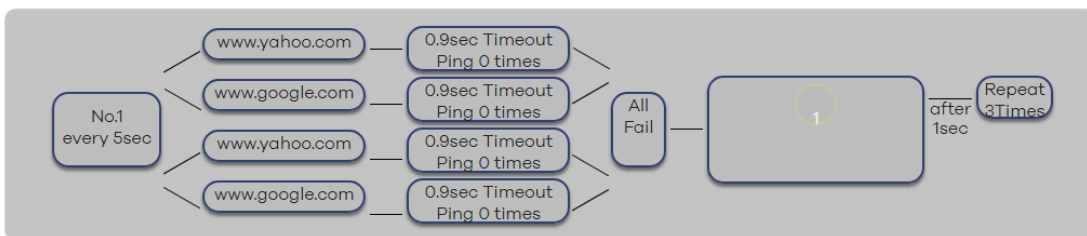

There are 3 sections of the setting area :

1. Setting Rule Numbers:

User can click to select different rules numbers at the right side button " Rule No: X " as following pictures .

[Ping List](#)

Global Ping Base Setting

| | | | |
|-------------------------|--|--------------------------|--|
| Ping Interval: | <input type="text" value="5"/> Sec. | Response Time Out: | <input type="text" value="900"/> ms. |
| Ping After Action Delay | <input type="text" value="1"/> Sec. | Action Max repeat Times: | <input type="text" value="3"/> (0=non stop) |

[Apply](#)

Logic Mode: Single OR And

| IP & Host Name | Failed times | Repeat |
|---|---------------------------------|------------------------------------|
| <input type="text" value="www.yahoo.com"/> Check | <input type="text" value="00"/> | Stop <input type="text" value=""/> |
| <input type="text" value="www.google.com"/> Check | <input type="text" value=""/> | <input type="text" value=""/> |
| <input type="text" value="www.yahoo.com"/> Check | <input type="text" value=""/> | <input type="text" value=""/> |
| <input type="text" value="www.google.com"/> Check | <input type="text" value=""/> | <input type="text" value=""/> |

Action

[Save](#) [Delete](#)

[Rule No1](#)

2. Ping Set:

[Ping List](#)

Global Ping Base Setting

| | | | |
|-------------------------|--|--------------------------|--|
| Ping Interval: | <input type="text" value="5"/> Sec. | Response Time Out: | <input type="text" value="900"/> ms. |
| Ping After Action Delay | <input type="text" value="1"/> Sec. | Action Max repeat Times: | <input type="text" value="3"/> (0=non stop) |

[Apply](#)

- Ping Interval : The number of seconds (Sec., 1~9999) between each ping .
- Response Time out : The number of milliseconds (ms., 1~9999) of the device will wait for a response from the Pinged device if no ping is detected within this time it will be considered a Ping failure.
- Ping After Action Delay : After ping finished , do the action after setting seconds (Sec.)
- Action Max repeat Times: Setup the times of Action after Ping Failure.
Set 0 means action non stop - Keep action & no limit times.

As setting finished, please click " Apply " to save the setting in this area , the webpage will refresh and user can see the final setting result. Ten different set up rules for different port.

3. Ping logic :

The setting here is for each rule.

| IP & Host Name | Failed times | Repeat |
|----------------|--------------|--------|
| www.yahoo.com | 00 | Stop |
| www.google.com | | |
| www.yahoo.com | | |
| www.google.com | | |

Action

Save Delete

➤ Ping logic:

User can select the action activate by one / two IP Host failure or either one fail.

- Single : Execute Action by one IP Host failure.
- OR : Execute Action by either one IP Host failure as setting 4 pcs IP Host.
- And : Execute Action by both IP Host failure as setting 4 pcs IP Host.

Single : 9855 PRO will Ping one IP address. As the IP fail times reach to the setting times. Action (ON/OFF/RESET) will be activated.

OR : 9855 PRO will Ping 4 IP address. Either one IP fail times reach to the setting times. Action (ON/OFF/RESET) will be activated.

And : 9855 PRO will Ping 4 IP address. Both IP fail reach to the setting times. Action (ON/OFF/RESET) will be activated.

| IP & Host Name | Failed times | Repeat |
|----------------|--------------|--------|
| www.yahoo.com | 00 | Stop |
| www.google.com | | |
| www.yahoo.com | | |
| www.google.com | | |

Action

Save Delete

- IP & Host Name : Input the IP Address (ex: 122.116.123.138) or Host - web address (ex: www.google.com) user would like to Ping. User can use the “ ping test ” bottom to check the address valid or not

➤ Failed times : Setup the times as get ping failure for 9855 PRO to execute the setup ON/OFF / Reset action of setting. ping one time and (range 00~99)

➤ Repeat : After the ON/OFF/Reset action , user can setup the Ping action to keep ping (Continue) or to Stop Ping (Stop).

➤ Enable Ping function : In the selected Rules number , please select the outlet number power to activate as ping fails and then press “ Save “ button to confirm the setting .

Ping List

Global Ping Base Setting

| | | | |
|-------------------------|-----------|--------------------------|-------------------|
| Ping Interval: | 5 Sec. | Response Time Out: | 900 ms. |
| Ping After Action Delay | 1 Sec. | Action Max repeat Times: | 3 (0=non stop) |

Apply

Logic Mode: Single OR And

| IP & Host Name | Check | Failed times | Repeat |
|----------------|-------|--------------|--------|
| www.yahoo.com | Check | 00 | Stop |
| www.google.com | Check | | |
| www.yahoo.com | Check | | |
| www.google.com | Check | | |

Action power1

OFF
ON
OFF
CYCLE

Save Delete

Rule No1

➤ Action :

When the number of Ping Failures times have been reached. The device can be set to “ ON , OFF or Reset ” function.

Reset: Can set up the time gap from OFF to ON. The “ Sec “ section is for action as Reset only.

- ON
- OFF
- Cycle: It means outlets turn OFF to ON

The setting times range is 1 to 999 sec.

Select the number of Ping Failures that user prefer to do before the action is activated.

EX: Result of setting

4.3.4 QR code

The QR code function operates by using the QR code icon within the device to perform I/O actions, linking to execute actions on scanner 9855 through scanning.



What you need to prepare?

1. A network cable, recommend to use the “thin” cable
2. A QR Barcode Scanner for PC (USB)

Connect to your IP POWER 9855, and plug your QR Barcode Scanner as the red arrow shown.

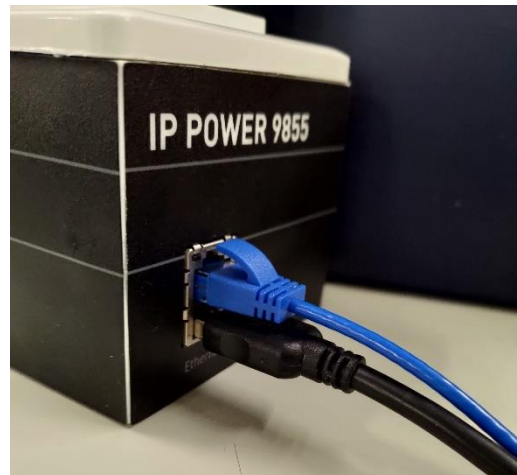

Except QR code, general code scanning can also be applied to the 9855, but you must first input the settings on the code scanning interface in order to control IO.

Every time you scan the QR code or other code, the “Counter” will count how many you scan it, you can reset to zero by click the apply.

For example:

This is the box with the code and barcode.



When you scan the barcode in the box, you can see the code in the webpage, it shows the number as same as the scanner bar shown. But it won't execute the device operating, you must input the code from the 9855's manual provide, you can see one of the code in the on/off picture below.

| ON | Counter | OFF |
|---|----------|--|
|  | 1 |  |

| System Information | |
|--------------------------------------|---------|
| Connect | connect |
| <input type="button" value="Apply"/> | |

14810

Scanning on and off QR code will trigger the IO control, and will show their command code below.

I/O control On code:

| ON | Counter | OFF |
|---|----------|--|
|  | 2 |  |

| System Information | |
|--------------------------------------|---------|
| Connect | connect |
| <input type="button" value="Apply"/> | |

```
cmd=setpower+p61=1
```

I/O control Off code:

| ON | Counter | OFF |
|---|----------|--|
|  | 3 |  |

| System Information | |
|--------------------------------------|---------|
| Connect | connect |
| <input type="button" value="Apply"/> | |

```
cmd=setpower+p61=0
```

4.4 Network

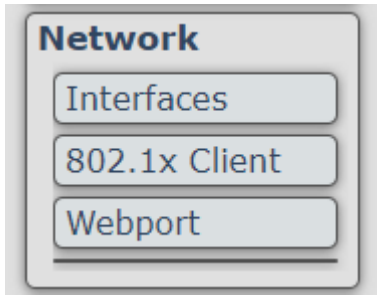

LAN Network Settings

The network status is connected by ether cable with RJ45 connector. There are **3** ways to connect the network : By DHCP Client, DHCPv6 Client and Static address.

Protocol

DHCP client

Device

DHCP client

DHCPv6 client

Static address



Bring up on boot



4.4.1 Interfaces

The interface shows the basic information of device's network, to change the setting, click the "edit" bottom.

interface

| | | |
|--|---|----------------------|
| lan  br-lan | Protocol: DHCP client Uptime: 1d 20h 52m 43s MAC: 00:76:56:00:43:21 RX: 147.97 MB (943404 Pkts.) TX: 13.67 MB (83652 Pkts.) IPv4: 10.33.122.43/24 | Edit |
| lan6  br-lan | Protocol: DHCPv6 client Uptime: 1d 20h 54m 5s MAC: 00:76:56:00:43:21 RX: 147.97 MB (943404 Pkts.) TX: 13.67 MB (83652 Pkts.) IPv6: 2001:b011:3801:3388:276:56ff:fe00:4321/64 | Edit |

Save & Apply

Save

Reset

A. Static Mode (fixed IP)

Setup IP address, DNS and Port manually. This allows the 9855 PRO to obtain an IP Address automatically from user`s server connected to Internet. Recommended for users who need to control through Internet.

Please do fill up the correct gateway / port for login from Internet .

Please do fill up the correct DNS server for sending / receiving email (alarm) .

Protocol: Static address

Interfaces >> lan

General Settings

| | |
|------------------------|---|
| Status | <div>Device: br-lan Uptime: 1d 22h 28m 29s MAC: 00:76:56:00:43:21 RX: 154.26 MB (985318 Pkts.) TX: 16.25 MB (90740 Pkts.) IPv4: 10.33.122.43/24</div> |
| Protocol | Static address |
| Device | br-lan |
| Bring up on boot | <input type="checkbox"/> |
| IPv4 address | <input type="text"/> |
| IPv4 netmask | unspecified |
| IPv4 gateway | 10.33.122.1 (lan) |
| IPv4 broadcast | <input type="text"/> |
| IPv6 address | Add IPv6 address... <input type="text"/> |
| IPv6 gateway | <input type="text"/> |
| IPv6 routed prefix | <input type="text"/> |
| Use custom DNS servers | <input type="text"/> |

Public prefix routed to this device for distribution to clients.

Dismiss Save

B. DHCP Mode

Obtain IP address via DHCP mode. setup the DNS and port

This allows the 9855 PRO to obtain an IP Address automatically from user`s server connected toInternet. Recommended for non- advance users.
User can only revise the Host Name under DHCP mode. This is also the default setting for fast LAN connection solution.

As the IP from DHCP Service of user`s router will be changed by router. 9855 PRO will remember last IP of 9855 PRO assigned by user`s router in “Last DHCP state” for information

When you switch the protocol to “DHCP Client”, it will appears “ Really switch protocol? ” line, remember to click it.

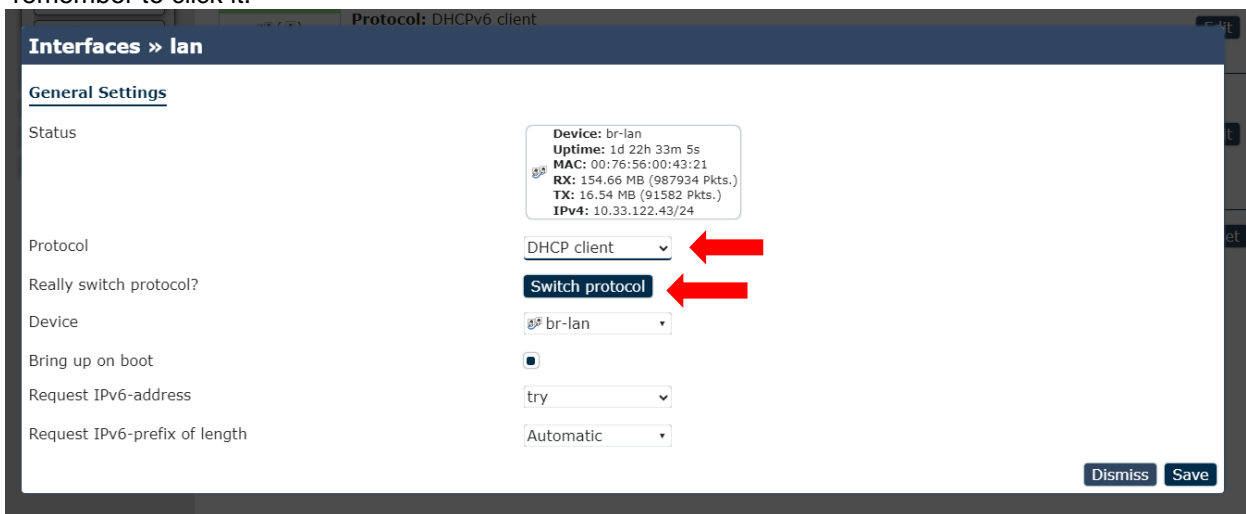

After click the “Switch protocol”, setting screen will show the new settings, remember to click save after you complete your settings.



4.4.2 802.1X Client

To configure IEEE 802.1X wired authentication, you may need to edit your interface protocol as DHCP client here.

802.1x Client

Configure IEEE 802.1x wired authentication, you may need to edit your interface protocol as *DHCP* client here

| | |
|------------|-------------------------------------|
| Enable | <input type="checkbox"/> |
| Username | <input type="text"/> |
| Password | <input type="text"/> |
| Interfaces | <input type="text" value="br-lan"/> |
| EAP | <input type="text" value="MD5"/> |

Enable: If you want to enable it, click the icon, if don't, do not click it.

Username: Edit your username

Password: Edit your password

Interfaces: currently only provides "br-lan"

EAP: MD5, PEAP, MSCHPV2

After you finish the setting, remember to click the "save" to save it.

4.4.3 Web Port

A lightweight single-threaded HTTP(S) server

General Settings:

Port

port setting

MAIN

General Settings

HTTP listeners (address:port)

| | |
|---|---|
| <input type="text" value="0.0.0.0:80"/> | - |
| <input type="text" value="[:]:80"/> | - |
| <input type="text"/> | + |

Bind to specific interface:port (by specifying interface address)

HTTPS listener (address:port)

| | |
|--|---|
| <input type="text" value="0.0.0.0:443"/> | - |
| <input type="text" value="[:]:443"/> | - |
| <input type="text"/> | + |

Bind to specific interface:port (by specifying interface address)

Redirect all HTTP to HTTPS

HTTPS Certificate (DER or PEM format)

HTTPS Private Key (DER or PEM format)

Remove old certificate and key

generate a new self-signed certificate using the configuration shown below.

Remove configuration for certificate and key

This permanently deletes the cert, key, and configuration to use same.

Self-signed Certificate Parameters

Valid for # of Days

Length of key in bits

Server Hostname

a.k.a CommonName

Organization

If empty, a random/unique value is used in cert generation

Location

State

Country

For example:

Port

port setting

MAIN

General Settings

HTTP listeners (address:port)

| | | |
|------------|---|-----|
| 0.0.0.0:80 | - | (1) |
| :::80 | - | (2) |
| | + | (3) |

Bind to specific interface:port (by specifying interface address)

HTTPS listener (address:port)

| | | |
|-------------|---|-----|
| 0.0.0.0:443 | - | (1) |
| :::443 | - | (2) |
| | + | (3) |

Bind to specific interface:port (by specifying interface address)

Redirect all HTTP to HTTPS

Device's IP: 0.0.0.0, (ex: 192.168.1.xx or 10.33.122.xx)

port: 80(HTTP). 443(HTTPS) (the ports number depends on the router setting)

1. HTTP listeners (address: port): Bind to specific interface:port by specifying interface address.

(1) Port section: "0.0.0.0" is your IP device, 80 is the port you type

If fill 0.0.0.0 here, 9855 PRO recognize the IP as the device IP address

For example: if the IP address of the 9855 PRO is 192.168.1.168:80

User can fill: 0.0.0.0:80 which also mean 192.168.1.168:80

User can also fill 192.168.1.168:80 here.

(2) This section shows the format of IPV6, as the (1) shows how IP address works, user have to follow the format to type new IP address like: :::80 or :::443 ...etc

(3) Type new port : Add new port for IPV4 or IPV6 section, then click the dark blue "+" bottom, and click save & apply, settings complete.

2. HTTPS listeners (address: port): Bind to specific interface:port(by specifying interface address. Same procedure as "1. HTTP listeners"

3. Redirect all HTTP to HTTPS: User can enable this section and which will Direct HTTPS only, and disable HTTP.

4. HTTPS Certificate (DER or PEM format): Upload certificate Der or PEM file.

5. HTTPS Private Key (DER or PEM format): Upload Private key DER or PEM file.

6. Remove old certificate and key: Generate a new self-signed certificate using the configuration shown below.

7. Remove configuration for certificate and key: This permanently deletes the cert, key, and configuration to use same.

4.5 System

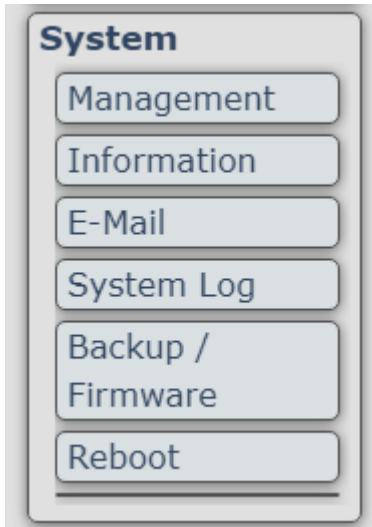

4.5.1 Management

In this section there are 6 settings: System, Password, SSH Access, SSH-Keys, HTTP(S) Access, ACL settings

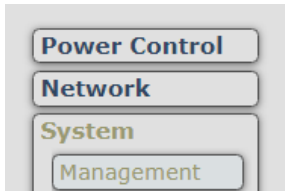

[System](#) [Password](#) [SSH Access](#) [SSH-Keys](#) [HTTP\(S\) Access](#) [ACL Settings](#)

Time & Language

Here you can configure the basic aspects of your device like its Language or the timezone.

System:

[System](#) [Password](#) [SSH Access](#) [SSH-Keys](#) [HTTP\(S\) Access](#) [ACL Settings](#)

Time & Language

Here you can configure the basic aspects of your device like its Language or the timezone.

[General Settings](#) [Time Synchronization](#) [Language](#)

| | | | |
|------------|---------------------|-----------------------------------|--------------------------------------|
| Local Time | 2023-06-19 10:59:08 | Sync with browser | Sync with NTP-Server |
| | 2023-06-19 10:59:01 | Set time manual | |
| Timezone | Asia/Taipei | | |

[Save & Apply](#) [Save](#) [Reset](#)

(1) General setting:

1-1 Local Time: Sync the local time through browser, NTP-server or manual setting.

1-2 Timezone: Change your timezone setting.

(2) Time Synchronization:

Enable NTP client and DHCP function, and set your NTP server candidate.

[System](#) [Password](#) [SSH Access](#) [SSH-Keys](#) [HTTP\(S\) Access](#) [ACL Settings](#)

Time & Language

Here you can configure the basic aspects of your device like its Language or the timezone.

[General Settings](#) [Time Synchronization](#) [Language](#)

| | | | | | | | | | | | |
|-----------------------------|---|------------------------|---|------------------------|---|------------------------|---|------------------------|---|--|---|
| Enable NTP client | <input checked="" type="checkbox"/> | | | | | | | | | | |
| Use DHCP advertised servers | <input checked="" type="checkbox"/> | | | | | | | | | | |
| NTP server candidates | <table><tr><td>0.openwrt.pool.ntp.org</td><td>-</td></tr><tr><td>1.openwrt.pool.ntp.org</td><td>-</td></tr><tr><td>2.openwrt.pool.ntp.org</td><td>-</td></tr><tr><td>3.openwrt.pool.ntp.org</td><td>-</td></tr><tr><td></td><td>+</td></tr></table> | 0.openwrt.pool.ntp.org | - | 1.openwrt.pool.ntp.org | - | 2.openwrt.pool.ntp.org | - | 3.openwrt.pool.ntp.org | - | | + |
| 0.openwrt.pool.ntp.org | - | | | | | | | | | | |
| 1.openwrt.pool.ntp.org | - | | | | | | | | | | |
| 2.openwrt.pool.ntp.org | - | | | | | | | | | | |
| 3.openwrt.pool.ntp.org | - | | | | | | | | | | |
| | + | | | | | | | | | | |

[Save & Apply](#) [Save](#) [Reset](#)

(3) Language

There are 3 language option of 9855 PRO .The default language is English.
The other two languages are “Chinese(Simplified)” and “ Taiwanese(Traditional Chinese)” .

[System](#) [Password](#) [SSH Access](#) [SSH-Keys](#) [HTTP\(S\) Access](#) [ACL Settings](#)

Time & Language

Here you can configure the basic aspects of your device like its Language or the timezone.

[General Settings](#) [Time Synchronization](#) [Language](#)

| | | | | | | | | | | | |
|----------------------------|--|---------|---|------|--|---------|--|---------------------------|--|----------------------------|--|
| Language | <table><tr><td>English</td><td>▼</td></tr><tr><td>auto</td><td></td></tr><tr><td>English</td><td></td></tr><tr><td>简体中文 (Chinese Simplified)</td><td></td></tr><tr><td>繁體中文 (Chinese Traditional)</td><td></td></tr></table> | English | ▼ | auto | | English | | 简体中文 (Chinese Simplified) | | 繁體中文 (Chinese Traditional) | |
| English | ▼ | | | | | | | | | | |
| auto | | | | | | | | | | | |
| English | | | | | | | | | | | |
| 简体中文 (Chinese Simplified) | | | | | | | | | | | |
| 繁體中文 (Chinese Traditional) | | | | | | | | | | | |

[Save & Apply](#) [Save](#) [Reset](#)

System Password:

Change the administrator password for accessing the device.

[System](#) [Password](#) [SSH Access](#) [SSH-Keys](#) [HTTP\(S\) Access](#) [ACL Settings](#)

Password

Changes the administrator password for accessing the device

Password *

Confirmation *

SSH Access:

Dropbear offers SSH network shell access and an integrated SCP server.

[System](#) [Password](#) [SSH Access](#) [SSH-Keys](#) [HTTP\(S\) Access](#) [ACL Settings](#)

SSH Access

Dropbear offers [SSH](#) network shell access and an integrated [SCP](#) server

Dropbear Instance

Interface

Delete

Listen only on the given interface or, if unspecified, on all

Port

Password authentication

Allow [SSH](#) password authentication

Allow root logins with password

Allow the `root` user to login with password

Gateway Ports

Allow remote hosts to connect to local SSH forwarded ports

Add instance

Save & Apply

Save

Reset

SSH-Keys:

Public keys allow for the passwordless SSH logins with a higher security compared to use of plain passwords. In order to upload a new key to the device, paste an OpenSSH compatible public key line or drag a .pub file into the input field.

[System](#) [Password](#) [SSH Access](#) [SSH-Keys](#) [HTTP\(S\) Access](#) [ACL Settings](#)

SSH-Keys

Public keys allow for the passwordless SSH logins with a higher security compared to the use of plain passwords. In order to upload a new key to the device, paste an OpenSSH compatible public key line or drag a .pub file into the input field.

No public keys present yet.

[Add key](#)

HTTP(S) Access:

uHTTPd offers HTTP or HTTPS network access

[System](#) [Password](#) [SSH Access](#) [SSH-Keys](#) [HTTP\(S\) Access](#) [ACL Settings](#)

HTTP(S) Access

uHTTPd offers [HTTP](#) or [HTTPS](#) network access.

Settings

Redirect to HTTPS

Enable automatic redirection of [HTTP](#) requests to [HTTPS](#) port.

[Save & Apply](#) [Save](#) [Reset](#)

ACL Settings:

Manage and create the list of account for different settings and authorized purpose.

[System](#) [Password](#) [SSH Access](#) [SSH-Keys](#) [HTTP\(S\) Access](#) [ACL Settings](#)

LuCI Logins

| Login name | Session timeout | Read access | Write access | |
|------------|-----------------|----------------------|------------------------|---|
| root | 300s | full | full | Edit Delete |
| guest | 300s | full | denied | Edit Delete |
| admin | 300s | full | full | Edit Delete |

[Add](#)

[Save & Apply](#) [Save](#) [Reset](#)

For example:

1. root: Can normally operate all the function
2. guest: The authorized only for read access, can't control the device.
3. admin: For the user who used to operate old CGI http command from other IP Power devices.
The user still can use the other IP Power http command through "admin" user.

4.5.2 Information

User can get the system information here.

Status

System

| | |
|------------------|---------------------|
| Hostname | IP_POWER |
| Firmware Version | v1.10_2023_6_26_op |
| Hardware Version | IP9855V1000 |
| UBoot Version | 4.4.1.8 |
| Web Port | 0.0.0.0:80,[::]:80 |
| Local Time | 2023-06-27 07:04:28 |
| Uptime | 4h 57m 8s |

Network

IPv4 Upstream

Protocol: DHCP client
Address: 10.33.122.2/24
Gateway: 10.33.122.1
DNS 1: 8.8.8.8
DNS 2: 1.1.1.1
DNS 3: 168.95.192.1
DNS 4: 168.95.1.1
Expires: 19h 3m 41s
Connected: 4h 56m 19s

Device: Bridge: "br-lan"
MAC address: 00:76:56:00:01:08

IPv4 Upstream

Protocol: DHCP client
Address: 10.33.122.5/24
Gateway: 10.33.122.1
DNS 1: 168.95.192.1
DNS 2: 168.95.1.1
Expires: 23h 33m 10s
Connected: 0h 26m 50s

Device: Wireless Network: Client "aviosys-10-2.4G"
MAC address: 00:76:56:00:01:09

IPv6 Upstream

Protocol: DHCPv6 client
Address: 2001:b011:3801:3388:276:56ff:fe00:108/64
Gateway: fe80::1e5f:2bff:fe66:a574
DNS 1: 2001:b000:168::2
DNS 2: 2001:b000:168::1
Connected: 4h 56m 15s

Device: Bridge: "br-lan"
MAC address: 00:76:56:00:01:08

Active Connections 137 / 8192 (1%)

4.5.3 Email

e-Mail

The SMTP function offers mail agent to send event notification to mail receiver

SMTP config

| | |
|----------|---|
| From | <input type="text" value="aviosys1@gmail.com"/> |
| Server | <input type="text" value="smtp.gmail.com"/> |
| To: | <input type="text" value="aviosys101@gmail.com"/> |
| Port | <input type="text" value="587"/> |
| tls | <input type="checkbox"/> |
| Account | <input type="text" value="aviosys1"/> |
| Password | <input type="password" value="....."/> |

➤ Email Setting :

User can get e-mail advice as one of the following situation happen:

- Receive E-mail with IP information & MAC Address as 9855 PRO device boot up.
- Receive E-mail as ON/OFF status change in each output.

Notice : To send out the e-mail successfully , please double check the setting of user DNS . (Network → Interface → DNS setting)

The 9855 PRO allows user to send from public e-mail account , such as @gmail or @hotmail or @yahoo.com

- **From :** Mail sender address to send the E-Mail out. Ex.: 9855_PRO@gmail.com
- **Server (SMTP):** This is the mail server of sender

If user select @gmail or @hotmail account as SMTP Server , 9855 PRO will fill the SSL & Port automatically

- **To :** Mail receiver address to get the E-Mail in. Ex.: 9223@hotmail.com
- **Server :** Please refer to P.37 Server(SMTP)
- **Port :** This is the port of SMTP Server. Most common port to send out e-mail is port 25
- **TLS :** It depends on the inquire of the email server to enable or disable this inquire .As use Gmail account , please enable this function.
- **Account :** Login for the e-mail address . Ex: 9855_PRO@gmail.com
- **Password:** Password for the e-mail address. EX : 12345678
- **Verify:** A send e-mail test to make sure the e-mail works.
- **Save:** To store the setting in this section.

For example :

Get Email alarm as outlet changed :

User can enable the **Email Alerts** in the advance setting section :

Power Control → Control →Advanced setting

Control

| | |
|---|---|
| Outlet1 | <input type="text" value="power1"/> |
| Disable Control Button | <input type="checkbox"/> |
| Disable Power cycle Button | <input type="checkbox"/> |
| Email Alerts | <input type="checkbox"/> |
| Beep Alert | <input type="checkbox"/> |
| Power Cycle Time | <input type="text" value="60"/> Seconds |
| Current (1-10)Amp | <input type="text" value="8"/> |
| Temperature Limit:0-60°C Low: <input type="text" value="0.0"/> High: <input type="text" value="60"/> | <input type="text" value="None"/> |
| Default Power Status | <input type="text" value="LAST"/> |

Save

4.5.4 System Log

In this section, user can get the 9855 PRO system operation information and send the information to assign Server IP address (not support name) . **The system information will be deleted after 9855 PRO device power reboot.**

Setup:

Setup the IP & port to transfer the log list to external server.

System log

Setup Log

| | |
|-------------------------------------|--------------------------------------|
| External system log server | <input type="text" value="0.0.0.0"/> |
| External system log server port | <input type="text" value="514"/> |
| External system log server protocol | <input type="text" value="UDP"/> |
| Log output level | <input type="text" value="Debug"/> |
| Cron Log Level | <input type="text" value="Debug"/> |

Apply

- 1. External system log server: Set the IP device that transfer the log list to another server.**
- 2. External system log sever port: Set the port of the external server.**
- 3. External system log server protocol : select UDP or TCP mode**
- 4. Log output level : select level – Debug , Info , Notice , Warning , Error , Critical , Alert & Emergency**
- 5. Corn log level : select Normal or warning**

Please click “ Apply ” after you change the settings.

System Log:

Setup:

System log

Setup Log

| | |
|-------------------------------------|--------------------------------------|
| External system log server | <input type="text" value="0.0.0.0"/> |
| External system log server port | <input type="text" value="514"/> |
| External system log server protocol | <input type="text" value="UDP"/> |
| Log output level | <input type="text" value="Debug"/> |
| Cron Log Level | <input type="text" value="Debug"/> |

Apply

Log:

System log

Setup Log

```
daemon.err ALL
2023-06-21T01:05:28, : 45347.055285 Poll UPS [myups@localhost] failed - Driver not connected
2023-06-21T01:05:33, : 45352.056565 Poll UPS [myups@localhost] failed - Driver not connected
2023-06-21T01:05:38, : 45357.057845 Poll UPS [myups@localhost] failed - Driver not connected
2023-06-21T01:05:43, : 45362.059265 Poll UPS [myups@localhost] failed - Driver not connected
2023-06-21T01:05:48, : 45367.060550 Poll UPS [myups@localhost] failed - Driver not connected
2023-06-21T01:05:53, : 45372.061914 Poll UPS [myups@localhost] failed - Driver not connected
2023-06-21T01:05:58, : 45377.063187 Poll UPS [myups@localhost] failed - Driver not connected
2023-06-21T01:06:03, : 45382.064465 Poll UPS [myups@localhost] failed - Driver not connected
2023-06-21T01:06:08, : 45387.065743 Poll UPS [myups@localhost] failed - Driver not connected
2023-06-21T01:06:13, : 45392.067024 Poll UPS [myups@localhost] failed - Driver not connected
2023-06-21T01:06:18, : 45397.068315 Poll UPS [myups@localhost] failed - Driver not connected
2023-06-21T01:06:23, : 45402.069653 Poll UPS [myups@localhost] failed - Driver not connected
2023-06-21T01:06:28, : 45407.070917 Poll UPS [myups@localhost] failed - Driver not connected
2023-06-21T01:06:28, : 45407.071018 UPS myups@localhost is unavailable
2023-06-21T01:06:28, : > libmsock: using getaddrinfo
2023-06-21T01:06:28, : > AF_INET6
2023-06-21T01:06:28, : IPv6 address: 2404:6800:4008:c03::6c
2023-06-21T01:06:28, : > EINPROGRESS=150,EWOULDBLOCK=11
2023-06-21T01:06:28, : > connect(): socket=3,rc=-1, errno=150
2023-06-21T01:06:28, : > Try socket 3
2023-06-21T01:06:28, : > Setting read timeout to: 5 seconds
2023-06-21T01:06:29, : > Setting read timeout to: 5 seconds
2023-06-21T01:06:29, : > Setting read timeout to: 5 seconds
2023-06-21T01:06:29, : > Setting read timeout to: 5 seconds
2023-06-21T01:06:29, : > Setting read timeout to: 5 seconds
2023-06-21T01:06:29, : > Setting read timeout to: 5 seconds
2023-06-21T01:06:29, : > Setting read timeout to: 5 seconds
```

4.5.5 Backup / Flash firmware

Flash Operations:

Please only use the file supply from Aviosys distributor or Aviosys.

There are three sections: Backup, Restore and Upgrade Firmware

The firmware update function only support in LAN connection.

Before update, please DO READ THE HI-LITE MESSAGE BLOW:

Backup: To download a tar archive of the current configuration files.

Restore(Factory reset): To reset the default setting or restore the configuration files.

Upgrade firmware: Upload and upgrade the latest firmware to replace current firmware.

It takes about 1 minute to upload upgrade flash and be patient please. Caution! A corrupted image will hang up the system. And the update will reset the device setting after its done.

* Please backup your setting if you want to restore it after the updating the firmware.

Flash operations

Actions

Backup

Click "Generate archive" to download a tar archive of the current configuration files.

Download backup

Generate archive

Restore

To restore configuration files, you can upload a previously generated backup archive here. To reset the firmware to its initial state, click "Perform reset" (only possible with squashfs images).

Reset to defaults

Perform reset

Restore backup

Upload archive...

Custom files (certificates, scripts) may remain on the system. To prevent this, perform a factory-reset first.

Upgrade Firmware

Upload a sysupgrade-compatible image here to replace the running firmware.

Image

Flash image...

To update the 9855 PRO, please follow the instruction below to prevent anything happens like **update incomplete** or **hardware disable** which may be caused by wrongdoing of updating:

- 1) Turn off all chat programs including (Skype, FB, QQ, AIM, Yahoo messengeretc.)
- 2) Check to make sure that all devices are turned on safely and powered
- 3) While updating do not turn off the power
- 4) Make sure that the cable is connected firmly
- 5) Do not interrupt the update process, the update must be completely finished .
- 6) Turn off, any Spyware or antivirus software which may conflict with the update.
- 7) Update firmware in the Local Area Network (LAN)
- 8) Please change the PORT as 80
- 9) **Reboot and Do the Hardware Reset** (keep pressing RESET button for 7 secs) after update successfully.
- 10) The update will turn back to the default settings, 9855 PRO's devices IP address will turn back to IP: 192.168.1.168. Please open your IPedit and Rescan it to find your device, you can check your device through MAC.
- 11) **Clear the Cookies and Cache from the temporary file of PC and browser** to avoid get the old webpage.

Note: Step 11 is vital procedure, please remember to do this after you update your device!!

Reminder: When you update the firmware, the final procedure screen will display an icon with the message "**Keep settings and retain the current configuration.**" Please refrain from clicking it if you wish to complete your firmware upgrade.

* If you wish to reset your firmware, click on the "**Keep settings and retain the current configuration**" icon. This action will save your current settings but will not upgrade your device's firmware; it will only refresh it.

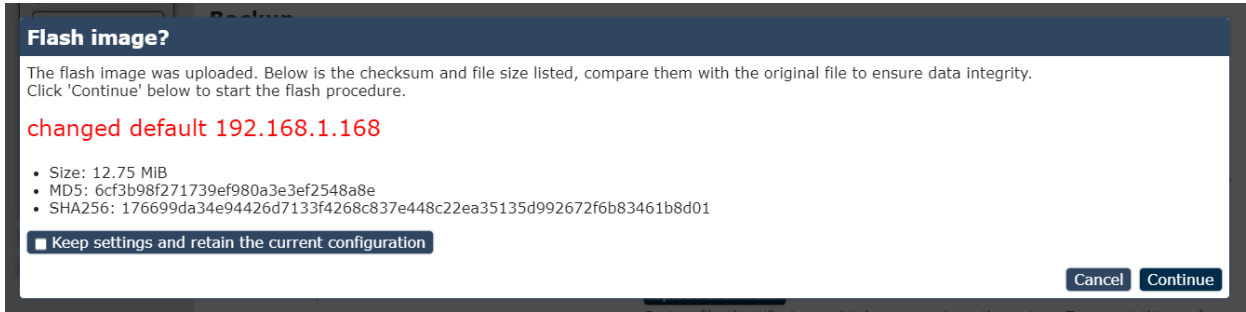

4.5.6 Reboot

Reboots the operating system of your device.

Reboot

Reboots the operating system of your device

Perform reboot

4.6 Application

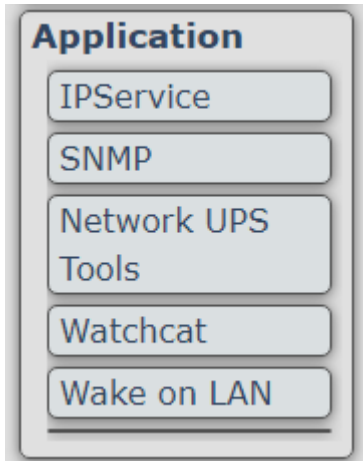

4.6.1 IP Service

In this section, user can setup :

- A. IP Server setting(Search)
- B. CNT2 (MQTT)Setting(Remote Control)

| IP Service Setting (Search) | |
|-------------------------------------|--------------------------|
| Enable | <input type="checkbox"/> |
| IP Service Server | Server1 ▼ |
| Device Name: | IPPower |
| Country | Country |
| City | City |
| Find IPPower device on myipedit.com | |
| <input type="button" value="Save"/> | |

| CNT(MQTT) Setting (Remote control) | |
|-------------------------------------|--------------------------|
| MQTT Service | IPPower ▼ |
| Enable | <input type="checkbox"/> |
| Status | |
| <input type="button" value="Save"/> | |

A. IP Service Setting (Search)

The IP SERVICE allow 9855 PRO to be accessed easily on the internet by our IP Power Center or IPEDIT. With this feature anyone can find its device with no problems.

IP Service Server: Allows user can find user of 9855 PRO on the internet without having to remember long IP Addresses. Instead user can just remember the name of user device.

IP Service Setting (Search)

Enable

IP Service Server: Server1

Device Name: IPPower

Country: Country

City: City

Find IPPower device on myipedit.com

- Enable : Enable or Disable this function by clicking the small box .
- IP Service Server : Custom – the server setting by yourself
Server 1- the server from our company
- Device name, Country & City:

User can search the 9855 PRO by Device name, Country or City.

This allows the device to be accessed easily on the Internet, user no longer have to Port Forwarding, user device to be able to use it. Only some devices are CNT compatible.

Please refer page #14 for the function of IP Server

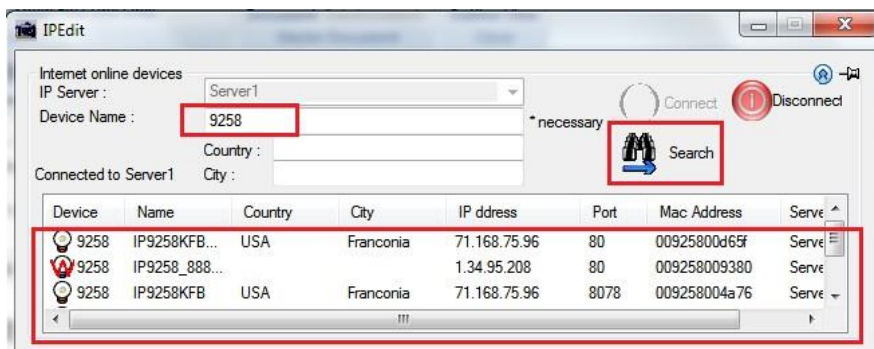

B. CNT (MQTT) Setting (Remote control)

For developing only. 9855 PRO supports MQTT function. Please contact with your distributor for the details if you would like to develop own system.

CNT(MQTT) Setting (Remote control)

MQTT Service: IPPower

Enable

Status

4.6.2 SNMP

This section is for development of system integrator who is familiar with SNMP knowledge. In Authority, user can select “ Read only” or “Read / Write”

| | |
|-----------|--------------------------|
| Enable | <input type="checkbox"/> |
| Version | v1 |
| Authority | Read/Write |
| community | Read only Read/Write |

In “ Trap “ type ,user can select “ trapsink “ , “ trap2sink “ or “ informsink ”

| | |
|-----------|---------------------------|
| Trap type | none |
| host | |
| community | |
| port | |
| EngineID | 0x80000000000007656004321 |

SNMP Version: IP9855 PRO provide V1, V2 and V3 version. V1 and V2 remain the same settings, when you switch to V3, user can see the difference in the second picture.

| | |
|-----------|--------------------------|
| Enable | <input type="checkbox"/> |
| Version | v1 |
| Authority | v1 v2c v3 |
| community | private |

| | |
|-----------|---------------------------|
| Trap type | none |
| host | 192.168.1.1 |
| community | private |
| port | 162 |
| EngineID | 0x80000000000007656004321 |

SNMP V3: Version V3 add new function, these are: auth, MD5 and DES

| | |
|-----------|---------------------------|
| Enable | <input type="checkbox"/> |
| Version | v3 |
| User | admin |
| auth | authPriv |
| MD5 | |
| DES | |
| Trap type | none |
| host | 192.168.1.1 |
| community | private |
| port | 162 |
| EngineID | 0x80000000000007656004321 |

- (1) auth: this function provide the certified and encryption to the device.
User can choose enable(authPriv) or disable(authNoPriv) the certified encryption.

| | |
|---------|--------------------------|
| Enable | <input type="checkbox"/> |
| Version | v3 |
| User | admin |
| auth | authPriv |
| MD5 | |
| DES | |

- (2) MD5: Setting your password for certified.
- (3) DES: Setting your password for encryption.

| | |
|---------|--------------------------|
| Enable | <input type="checkbox"/> |
| Version | v3 |
| User | admin |
| auth | authPriv |
| MD5 | |
| DES | |

4.6.3 Network UPS Tools

This function can detect the electricity through UPS, plug by the USB port. After setting your user name and password, move to the (CGI) section, And click to “ NUT CGI”, you can see the status of UPS.

1. Network UPS Tools: (Server):
Network UPS tools server Configuration

[Network UPS Tools \(Server\)](#) [Network UPS Tools \(Monitor\)](#) [Network UPS Tools \(CGI\)](#)

Network UPS Tools (Server)

Network UPS Tools Server Configuration

NUT Users

| | |
|--|--|
| Username | <input type="text" value="upsmon"/> |
| Password | <input type="password" value="*****"/>  |
| Role | <input type="text" value="Master"/> ▼ |
| <input type="text" value="-- Additional Field --"/> <input type="button" value="Add"/> | |
| <input type="button" value="Add"/> | |

Addresses on which to listen

| | |
|------------------------------------|--------------------------------------|
| IP Address | <input type="text" value="0.0.0.0"/> |
| Port | <input type="text" value="3493"/> |
| <input type="button" value="Add"/> | |

Driver Configuration

The name of this section will be used as UPS name elsewhere

| | |
|--|---|
| Driver | <input type="text" value="usbhid-ups"/> ▼ |
| Port | <input type="text" value="auto"/> |
| <input type="text" value="-- Additional Field --"/> <input type="button" value="Add"/> | |
| <input type="button" value="Add"/> | |

- (1) Username: Setting the username to login
- (2) Password: Setting the password to login
- (3) Role: Switch device role to Master or Slave

Warning: Except NUT users, don't change others settings in the red square, only if you are familiar with these function, you can attempt to setting by your own.

2. Network UPS Tools: (Monitor) Network UPS tools monitoring Configuration

[Network UPS Tools \(Server\)](#) [Network UPS Tools \(Monitor\)](#) [Network UPS Tools \(CGI\)](#)

Network UPS Tools (Monitor)

Network UPS Tools Monitoring Configuration

Global Settings

| | |
|---|---|
| RunAs User | <input type="text" value="nutmon"/> <small>upsmon drops privileges to this user</small> |
| Notify command | <input type="text" value="/usr/bin/notifycmd"/> |
| Notification defaults | <input type="text" value="-- Please choose --"/> <input type="text" value="Execute notify command"/> <input type="text" value="Write to syslog"/> |
| Notify when on battery | <input type="text" value="-- Please choose --"/> <input type="text" value="Execute notify command"/> <input type="text" value="Write to syslog"/> |
| <input type="text" value="-- Additional Field --"/> | <input type="button" value="Add"/> |

UPS Master

| | | |
|---|---|---------------------------------------|
| Name of UPS | <input type="text" value="myups"/> <small>As configured by NUT</small> | <input type="button" value="Delete"/> |
| Hostname or address of UPS | <input type="text" value="localhost"/> | |
| Power value | <input type="text" value="1"/> | |
| Username | <input type="text" value="upsmon"/> | |
| Password | <input type="password" value="*****"/> | <input type="button" value="+"/> |
| <input type="text" value="-- Additional Field --"/> | <input type="button" value="Add"/> | |
| <input type="button" value="Add"/> | | |

3. Network UPS Tools: (CGI) Network UPS tools CGI Configuration

[Network UPS Tools \(Server\)](#) [Network UPS Tools \(Monitor\)](#) [Network UPS Tools \(CGI\)](#)

Network UPS Tools (CGI)

Network UPS Tools CGI Configuration

NUT CGI Access

Go to NUT CGI 

Host

| | | |
|---|---|---------------------------------------|
| UPS name | <input type="text" value="myups"/> <small>As configured by NUT</small> | <input type="button" value="Delete"/> |
| Hostname or IP address | <input type="text"/> | |
| Display name | <input type="text" value="root"/> | |
| <input type="text" value="-- Additional Field --"/> | <input type="button" value="Add"/> | |
| <input type="button" value="Add"/> | | |

Control UPS via CGI

Enable

NUT CGI Access

Click the " Go to Nut CGI " icon, you will see the screen show network UPS Tools



Statistics: Show the detect of UPS status.

Settings: (Under-development, please wait for advice)



Network UPS Tools upsstats 19.07.3-95-g1a68372
Tue Jan 17 05:18:30 UTC 2023

| System | Model | Status | Battery | Input (VAC) | Output (VAC) | Load (%) | UPS Temp | Battery Runtime | Data Tree |
|--------|-----------------|--------|---------|-------------|--------------|----------|----------|-----------------|--------------------------|
| root | HID UPS Battery | ONLINE | 99 % | 106.0 | 106.0 | 0 % | | 00:13:04 | All data |



4.6.4 Watchcat

Watchcat allows to configure a periodic reboot and/or when internet connection has been lost for a certain period of time.

(1) Operating mode: Each mode show different setting options.

1. Ping Reboot:

Reboot on internet connection mode: Detect the lost internet based on the Ping host and the period you setting.

For example, when you set the Ping host :192.168.1.128, and the period set on 1d=1 day or 16 h= 16 hours. If the detect no response, it will reboot the device automatically.

Watchcat

Here you can set up several checks and actions to take in the event that a host becomes unreachable. Click the **Add** button at the bottom to set up more than one action.

Watchcat

These rules will govern how this device reacts to network events.

General Settings

| | |
|-------------------------------------|---|
| Mode | <input type="text" value="Ping Reboot"/> |
| | <p>Ping Reboot: Reboot this device if a ping to a specified host fails for a specified duration of time. Periodic Reboot: Reboot this device after a specified interval of time. Restart Interface: Restart a network interface if a ping to a specified host fails for a specified duration of time. Run Script: Run a script if a ping to a specified host fails for a specified duration of time.</p> |
| Period | <input type="text" value="6h"/> |
| | <p>In Periodic Reboot mode, it defines how often to reboot. In Ping Reboot mode, it defines the longest period of time without a reply from the Host To Check before a reboot is engaged. In Network Restart or Run Script mode, it defines the longest period of time without a reply from the Host to Check before the interface is restarted or the script is run.</p> <p>The default unit is seconds, without a suffix, but you can use the suffix m for minutes, h for hours or d for days.</p> <p>Examples:</p> <ul style="list-style-type: none">• 10 seconds would be: 10 or 10s• 5 minutes would be: 5m• 1 hour would be: 1h• 1 week would be: 7d |
| Host To Check | <input type="text" value="8.8.8.8"/> |
| | <p>IP address or hostname to ping.</p> |
| Address family for pinging the host | <input type="text" value="any"/> |
| Check Interval | <input type="text" value="30s"/> |
| | <p>How often to ping the host specified above.</p> <p>The default unit is seconds, without a suffix, but you can use the suffix m for minutes, h for hours or d for days.</p> <p>Examples:</p> <ul style="list-style-type: none">• 10 seconds would be: 10 or 10s• 5 minutes would be: 5m• 1 hour would be: 1h• 1 week would be: 7d |
| Ping Packet Size | <input type="text" value="Standard: 56 bytes"/> |
| Force Reboot Delay | <input type="text" value="30"/> |
| | <p>Applies to Ping Reboot and Periodic Reboot modes When rebooting the router, the service will trigger a soft reboot. Entering a non-zero value here will trigger a delayed hard reboot if the soft reboot were to fail. Enter the number of seconds to wait for the soft reboot to fail or use 0 to disable the forced reboot delay.</p> |
| Interface | <input type="text" value="unspecified"/> |
| | <p>Interface to monitor and/or restart</p> |

Save & Apply **Save** **Reset**

1-1 Period:

In Periodic Reboot mode, it defines how often to reboot.

In Ping Reboot mode, it defines the longest period of time without a reply from the Host To Check before a reboot is engaged.

In Network Restart or Run Script mode, it defines the longest period of time without a reply from the Host to Check before the interface is restarted or the script is run.

The default unit is seconds, without a suffix, but you can use the suffix m for minutes, h for hours or d for days.

Examples:

10 seconds would be: 10 or 10s

5 minutes would be: 5m

1 hour would be: 1h

1 week would be: 7d

1-2 Host to Check: IP address or hostname to ping

1-3 Address family for pinging the host: Three options to choose- Any, IPv4, IPv6

1-4 Check Interval:

How often to ping the host specified above.

The default unit is seconds, without a suffix, but you can use the suffix m for minutes, h for hours or d for days.

Examples:

10 seconds would be: 10 or 10s

5 minutes would be: 5m

1 hour would be: 1h

1 week would be: 7d

1-5 Force reboot delay: Applies to Ping Reboot modes

When rebooting the router, the service will trigger a soft reboot, Entering a non-zero value here will trigger a delayed hard reboot if the soft reboot were to fail. Enter the number of seconds to wait for the soft reboot to fail or use 0 to disable the forced reboot delay.

1-6 Interface: Interface to monitor and/or restart.

2. Periodic reboot mode: In this mode, ping host and period are removed. The device will reboot based on the period time you set. For example, if the device set 24h to reboot, the reboot will follow the setting until the times up or reset the setting.

Watchcat

Here you can set up several checks and actions to take in the event that a host becomes unreachable. Click the **Add** button at the bottom to set up more than one action.

Watchcat

These rules will govern how this device reacts to network events.

General Settings

| | |
|-------------------------------------|--|
| Mode | <input type="text" value="Ping Reboot"/> <p>Ping Reboot: Reboot this device if a ping to a specified host fails for a specified duration of time. Periodic Reboot: Reboot this device after a specified interval of time. Restart Interface: Restart a network interface if a ping to a specified host fails for a specified duration of time. Run Script: Run a script if a ping to a specified host fails for a specified duration of time.</p> |
| Period | <input type="text" value="6h"/> <p>In Periodic Reboot mode, it defines how often to reboot. In Ping Reboot mode, it defines the longest period of time without a reply from the Host To Check before a reboot is engaged. In Network Restart or Run Script mode, it defines the longest period of time without a reply from the Host to Check before the interface is restarted or the script is run.</p> <p>The default unit is seconds, without a suffix, but you can use the suffix m for minutes, h for hours or d for days.</p> <p>Examples:</p> <ul style="list-style-type: none"> • 10 seconds would be: 10 or 10s • 5 minutes would be: 5m • 1 hour would be: 1h • 1 week would be: 7d |
| Host To Check | <input type="text" value="8.8.8.8"/> <p>IP address or hostname to ping.</p> |
| Address family for pinging the host | <input type="text" value="any"/> |
| Check Interval | <input type="text" value="30s"/> <p>How often to ping the host specified above.</p> <p>The default unit is seconds, without a suffix, but you can use the suffix m for minutes, h for hours or d for days.</p> <p>Examples:</p> <ul style="list-style-type: none"> • 10 seconds would be: 10 or 10s • 5 minutes would be: 5m • 1 hour would be: 1h • 1 week would be: 7d |
| Ping Packet Size | <input type="text" value="Standard: 56 bytes"/> |
| Force Reboot Delay | <input type="text" value="30"/> <p>Applies to Ping Reboot and Periodic Reboot modes When rebooting the router, the service will trigger a soft reboot. Entering a non-zero value here will trigger a delayed hard reboot if the soft reboot were to fail. Enter the number of seconds to wait for the soft reboot to fail or use 0 to disable the forced reboot delay.</p> |
| Interface | <input type="text" value="unspecified"/> <p>Interface to monitor and/or restart</p> |

Save & Apply Save Reset

3. Restart Interface mode: Restart a network interface if a ping to a specified host fails for a specified duration of time.

Here you can set up several checks and actions to take in the event that a host becomes unreachable. Click the **Add** button at the bottom to set up more than one action.

Watchcat

These rules will govern how this device reacts to network events.

General Settings

| | | |
|-------------------------------------|---|---|
| Mode | <input type="text" value="Restart Interface"/> | <p>Ping Reboot: Reboot this device if a ping to a specified host fails for a specified duration of time. Periodic Reboot: Reboot this device after a specified interval of time. Restart Interface: Restart a network interface if a ping to a specified host fails for a specified duration of time. Run Script: Run a script if a ping to a specified host fails for a specified duration of time.</p> |
| Period | <input type="text" value="6h"/> | <p>In Periodic Reboot mode, it defines how often to reboot. In Ping Reboot mode, it defines the longest period of time without a reply from the Host To Check before a reboot is engaged. In Network Restart or Run Script mode, it defines the longest period of time without a reply from the Host to Check before the interface is restarted or the script is run.</p> <p>The default unit is seconds, without a suffix, but you can use the suffix m for minutes, h for hours or d for days.</p> <p>Examples:</p> <ul style="list-style-type: none">• 10 seconds would be: 10 or 10s• 5 minutes would be: 5m• 1 hour would be: 1h• 1 week would be: 7d |
| Host To Check | <input type="text" value="8.8.8.8"/> | <p>IP address or hostname to ping.</p> |
| Address family for pinging the host | <input type="text" value="any"/> | |
| Check Interval | <input type="text" value="30s"/> | <p>How often to ping the host specified above.</p> <p>The default unit is seconds, without a suffix, but you can use the suffix m for minutes, h for hours or d for days.</p> <p>Examples:</p> <ul style="list-style-type: none">• 10 seconds would be: 10 or 10s• 5 minutes would be: 5m• 1 hour would be: 1h• 1 week would be: 7d |
| Ping Packet Size | <input type="text" value="Standard: 56 bytes"/> | |
| Interface | <input type="text" value="unspecified"/> | <p>Interface to monitor and/or restart</p> |
| Name of ModemManager Interface | <input type="text" value="unspecified"/> | <p>Applies to Ping Reboot and Restart Interface modes If using ModemManager, you can have Watchcat restart your ModemManger interface by specifying its name.</p> |
| Unlock Modem Bands | <input type="checkbox"/> | <p>If using ModemManager, then before restarting the interface, set the modem to be allowed to use any band.</p> |

3-1 Name of ModemManager Interface:

Applies to Ping Reboot and Restart interface modes it using ModemManager, you can have Watchcat restart your ModemManager interface by Specifying its name.

3-2 Unlock Modem Bands:

If using ModemManager, then before restarting the interface, set the modem to be allowed to use any bond

4. Run Script: Run a script if a ping to a specified host fails for a specified duration of time.

Watchcat

These rules will govern how this device reacts to network events.

General Settings

| | | |
|-------------------------------------|--|---|
| Mode | <input type="text" value="Run Script"/> | <p>Ping Reboot: Reboot this device if a ping to a specified host fails for a specified duration of time. Periodic Reboot: Reboot this device after a specified interval of time. Restart Interface: Restart a network interface if a ping to a specified host fails for a specified duration of time. Run Script: Run a script if a ping to a specified host fails for a specified duration of time.</p> |
| Script to run | <input type="text" value="/etc/watchcat.user.sh"/> | <p>Script to run when the host has not responded for the specified duration of time. The script is passed the interface name as \$1</p> |
| Period | <input type="text" value="6h"/> | <p>In Periodic Reboot mode, it defines how often to reboot. In Ping Reboot mode, it defines the longest period of time without a reply from the Host To Check before a reboot is engaged. In Network Restart or Run Script mode, it defines the longest period of time without a reply from the Host to Check before the interface is restarted or the script is run.</p> <p>The default unit is seconds, without a suffix, but you can use the suffix m for minutes, h for hours or d for days.</p> <p>Examples:</p> <ul style="list-style-type: none">• 10 seconds would be: 10 or 10s• 5 minutes would be: 5m• 1 hour would be: 1h• 1 week would be: 7d |
| Host To Check | <input type="text" value="8.8.8.8"/> | <p>IP address or hostname to ping.</p> |
| Address family for pinging the host | <input type="text" value="any"/> | |
| Check Interval | <input type="text" value="30s"/> | <p>How often to ping the host specified above.</p> <p>The default unit is seconds, without a suffix, but you can use the suffix m for minutes, h for hours or d for days.</p> <p>Examples:</p> <ul style="list-style-type: none">• 10 seconds would be: 10 or 10s• 5 minutes would be: 5m• 1 hour would be: 1h• 1 week would be: 7d |
| Ping Packet Size | <input type="text" value="Standard: 56 bytes"/> | |
| Interface | <input type="text" value="unspecified"/> | <p>Interface to monitor and/or restart</p> |

4-1 Script to run: Script to run when the host has not responded for the specified duration of time. The script is passed the interface name as \$1

4.6.5 Wake on Lan

Wake on LAN is a mechanism to remotely boot computers in the local network.

Wake on LAN

Wake on LAN is a mechanism to remotely boot computers in the local network.

| | | |
|---------------------------|--|---|
| Network interface to use | <input type="text" value="br-lan"/> | Specifies the interface the WoL packet is sent on |
| Host to wake up | <input type="text" value="-- Please choose --"/> | Choose the host to wake up or enter a custom MAC address to use |
| Send to broadcast address | <input type="checkbox"/> | |

[Wake up host](#)

- Network Interface to use: Specifies the interface the WoL, packet is sent on.
 - (1) Broadcast on all interfaces: All the function below will broadcast at the same time.
 - (2) eth0: Device's MAC address
 - (3) wlan0: Wireless lan
 - (4) br-lan: Ethernet
- Host to wake up: Choose the host to wake up or enter a custom MAC address to use.
- Send to broadcast address: Enable or disable the function

5. Other ways to control

Besides HTTPS/CGI command and SSH we supply here, 9855 PRO also support SNMP (MIB), Please check page #47 to check and enable the function.

5.1 CGI HTTP Commands

CGI Commands allow you to easily integrate the 9855 PRO with other systems and programs. Pleaseread the instructions carefully on how to use the Http:// Commands

To use http:// Commands open up a web browser and type in the command that you would like to use.

1. User authorization .There are 3 formats :

For example : IP address 192.168.1.18 , Username : root. Password : 12345678

1.1 <http://root:12345678@192.168.1.18/set.cmd?cmd=getpower>

1.2 <http://192.168.1.18/set.cmd?user=root+pass=12345678+cmd=getpower>

The above 2 way also for HTTPS

2. Command

set.cmd?cmd=

All command do not separate capital / lower case , the connect symbol between commands can be “+” , “&” and “?”.

2.1 To get firmware version : getversion

<http://192.168.1.18/set.cmd?cmd=getversion>

System return :

```
<!--CGI-DATABEG-->
```

```
<p>
```

```
Version=v1.09_418</p>
```

```
<!--CGI-DATAEND-->
```

2.2 To get MACaddress: getmac

<http://192.168.1.18/set.cmd?cmd=getmac>

System return:

```
<!--CGI-DATABEG-->
```

```
<p>
```

```
mac=007628000284</p>
```

```
<!--CGI-DATAEND-->
```

2.3 To get the status of power on/ off: getpower

<http://192.168.1.18/set.cmd?cmd=getpower>

System return:

CGI Command : Data follows

p61=0,

2.4 To set the power on / off : setpower&p6x=0 or 1

p6x=0 means off, p6x=1 means ON,

Example : Turn on POWER1 and turn off POWER1:

<http://192.168.1.18/set.cmd?cmd=setpower&p61=1>

System return: CGI Command : Data follows p61=1, p61=0

2.5 Setup power to reboot as RESET: setpowercycle& p6x=delayTime

; dealyTime mean the time (second) waitingfor reset

For example :

<http://192.168.1.18/set.cmd?cmd=setpowercycle&p61=5>

System return: CGI Command : Data follows

p61 cycle ok

2.6 Get current Amp value : getcurrent

For example :

<http://192.168.1.18/set.cmd?cmd=getcurrent>

System return:

```
<!--CGI-DATABEG-->
```

```
<p>
```

```
c61= 0.0, temp=28.3</p>
```

```
<!--CGI-DATAEND-->
```

5.2 SSH commands

To login to the 9855 PRO in SSH

- 1) Open the putty and select SSH, after typing your ID address, putty will appears the command line and ask for login.

Login : root

Password : 12345678 (**Note:** The password won't display when you type)

10.33.122.2 - PuTTY

```
login as: root
root@10.33.122.2's password: █
```

(2) Command list:

```
root@IPPower: ~
root@IPPower:~# ioctrl -h
**-----**
Usage: ioctrl
[-h | --help ].....: display this help
[-s | --setpower p6l=1 or 0].....: turn on/off ports on the device
[-l | --setcycle p6l=x (x=1~9999)].....: outlet, will turn 'off to on'
[-p | --getpower ]..: get the on/off status of the device
[-c | --current ].....: get the current value of the device
[-v | --getvoltage ].....: get the voltage value of the device
[-t | --temp ].....: get the temperature value of the device
[-r | --reboot ].....: System Restart
[-f | --version ].....: display version information
-----
root@IPPower:~# ioctrl -s p6=1
p6l ok,
root@IPPower:~# ioctrl -c
Current value: 0.0
root@IPPower:~# ioctrl -v
Voltage value: 105.00
root@IPPower:~# ioctrl -t
Temperature value: 30.30
Fahrenheit value: 86.5
root@IPPower:~# ioctrl -p
Power Status: 1
root@IPPower:~# █
```

6. FAQ :

Q1: Why can't I see the 9855 PRO's IP address in IPEDIT.exe

Ans.:

Please check if your 9855 PRO had boot up successfully. There is a short beep sound to show 9855 PRO boot up successfully after device power up for 45 seconds.

There are several possibilities for this issue as 9855 PRO boot up successfully :

1. Segment of your PC :

Please check the PC you use is under same LAN/ network / segment as 9855 PRO.

2. Firewall / Antivirus protection :

Please turn off some Anti-Virus / online chatting software.

3. Network card :

IPEDIT can only work for the PC with one network card. If there are more than 1 network card, include dynamic network card, please disable one and make sure the one you selected is Under the same segment with IP9855 PRO

If connect to PC directly, please wait for the boot up beep first and then connect the network cable to your PC. And the default IP is 192.168.1.168

Q2: Why can't I see my 9855 PRO after arrange the port forwarding in my router?

Ans : Please make sure the Network Type (Gateway) is correct - LAN or WAN .

Q3: Why can't I receive e-mail ?

Ans: Please check the DNS and GATEWAY setting first (Check user router or ask user ISP company).There is a test button for checking the setting success or fail to send e-mail.

Notice :

Under DHCP mode - 9855 PRO will get the Network type (Gateway) information automatically. But if under Static mode, please do fill up the correct Network type (gateway).

Step : Connect user PC and 9855 PRO to a router by LAN. Then **reboot 9855 PRO (MUST DO)**. After 45 seconds with a long beep sound, user can find the LAN IP of 9855 PRO by IPEIDT.exe

Q4: How can I reset to default:

Ans : Keep pressing the button of "RESET for 7 seconds and then release it.

To reset to original manufacture settings : press the reset button with a sharpen pin for 7 seconds then RELEASE. There will be total 4 beeps sound which means reset start and 9855 PRO will be rebooted itself -there is one beep after reboot, and most information go back to default setting (LAN IP)